



# **H** BUMPER

All Makes Catalog  
Popular Part Numbers

**H** HENDRICKSON  
*The World Rides On Us*

# WELCOME

## TO THE HENDRICKSON ALL MAKES BUMPER PROGRAM

Hendrickson is the leading tier one OEM supplier of heavy-duty truck bumpers for the North American commercial vehicle industry. Our commitment to quality and product innovation drives this industry leadership position, thus promoting the development of products that enhance vehicle styling and durability. Key capabilities, which include proprietary bumper forming technology and advanced metal materials, enable Hendrickson to manufacture aerodynamically contoured bumper designs that are durable yet lightweight.

Hendrickson has an extensive field sales, parts and service organization to support our customers around the globe — truck owners, dealers, fleets and OEMs. Our investment in new technologies will continue as we strive to deliver value to our customers. At Hendrickson, innovation never rests.

## TABLE OF CONTENTS

Bumper Materials and Technology .....	1
Understanding the Hendrickson All Makes Bumper Program .....	2
Ford® .....	3
Freightliner® .....	4
International® .....	13
Kenworth® .....	22
Mack® .....	28
Peterbilt® .....	32
Volvo® .....	37
Western Star® .....	41
AERO CLAD® Rock Screens .....	42
Genuine Hendrickson - All Makes Program .....	45

# BUMPER

## PRODUCTS AND TECHNOLOGY



### AERO CLAD® Stainless Steel Clad Aluminum

- Durable, bright mirrored finish
- Finish 10 times thicker than chrome
- Resists corrosion, cracking, pitting, peeling and fading
- Up to 50 percent lighter than steel options
- Lightweight design
- Minor abrasions can be buffed
- Full 5-year limited warranty\*



### Steel Chrome

- 1-year limited warranty\*
- Available in 7-gauge or 10-gauge steel
- Bright mirrored finish
- Many shapes available
- Customize your bumper with cutouts and road lights
- Also available in corrosion resistant E-coat finish, ready for top coat

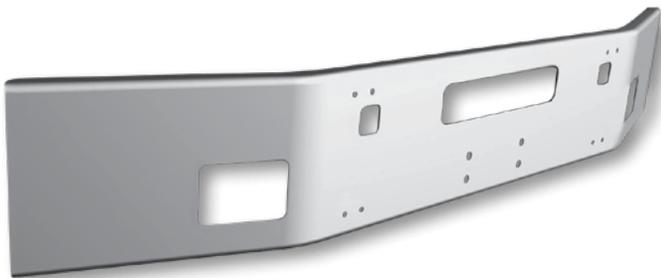

### Solid Stainless Steel

- Full 5-year limited warranty\*
- Bright mirrored finish
- Resists corrosion, cracking, pitting, peeling and fading
- As durable as a steel bumper
- Minor abrasions can be buffed

\* Visit our website at [www.hendricksonbumper.com](http://www.hendricksonbumper.com) or call 815.727.4031 for complete warranty terms, conditions and limitations.



# OVERVIEW

## HENDRICKSON ALL MAKES BUMPER PROGRAM

### PART NUMBERING ABBREVIATIONS

#### Part Prefixes:

Alpha characters designate exclusive bumpers available only through the OEM Truck Dealer.

**AM** - International®

**FF** - Freightliner®

**MM** - Mack® / Volvo®

#### Additional Abbreviations:

**AD** = Air Dam

**K** = Kit

**NL** = No Lights

**NS** = No Tire Shields

**SSC** = Stainless Steel Clad Aluminum

**SSCSQ** = Stainless Steel Clad Aluminum Texas Square

**STQ** = Solid Stainless Steel Texas Square

**SQ** = Texas Square

**TF** = Top Fillers

### ORDER / REORDER REQUIREMENTS

Direct Questions to Hendrickson Customer Service at **1-815-727-4031**, or OEM Customer Service Department.

### FREIGHT POLICY

Direct Questions to Hendrickson Customer Service at **1-815-727-4031**, or OEM Customer Service Department.

### INQUIRIES

Questions regarding literature, order status, warranty, returns and product information may be directed to Hendrickson Customer Service at **1-815-727-4031**, or OEM Customer Service Department.

### WARRANTY AND RETURN POLICY\*

**AERO CLAD®**: 5 years or 500,000 miles from date of sale.

**Steel Chrome**: 1 year or 100,000 miles from date of sale for materials and workmanship.

**Solid Stainless Steel**: 5 years or 500,000 from date of sale.

\* Visit our website at [www.hendricksonbumper.com](http://www.hendricksonbumper.com) or call 815.727.4031 for complete warranty terms, conditions and limitations.

## LN / LT / LTN / L8000 / 9000

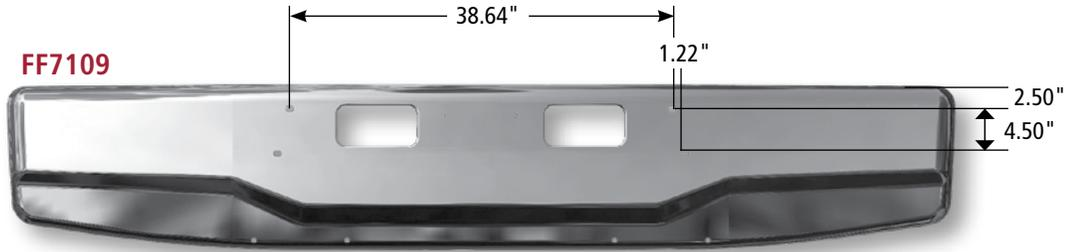

Ford® OEM L-Series 8000 and 9000

PART NO.	MATERIAL / FINISH	GAUGE / THICKNESS	STYLE	LIGHT	CENTER STEP	VENT	TOW	RADAR	EXCLUSIVE THROUGH OEM	YEAR	MOUNT / BRACKET
<b>FF7109</b>	Chrome	7Ga	16" Taper	N	N	N	Y	N	Y	'88 - '96	N

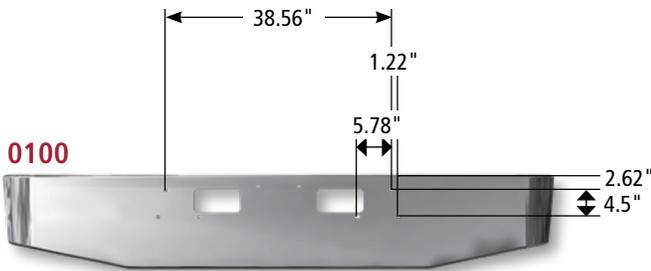

Ford L-Series conventional fits LN-LT-LTN 800, 900, 8000 and 9000 (Tow holes only). Fits trucks with 6V92 Detroit engine or 300 Cummins engine 1988 or newer (Axle forward only).

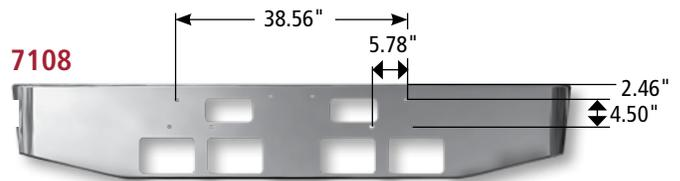

Ford Conventional LTL 9000 — Tow holes and four square light holes.

PART NO.	MATERIAL / FINISH	GAUGE / THICKNESS	STYLE	LIGHT	CENTER STEP	VENT	TOW	RADAR	EXCLUSIVE THROUGH OEM	YEAR	MOUNT / BRACKET
<b>0100</b>	Chrome	10Ga	16" Taper	N	N	N	Y	N	N	'88 - '96	N
<b>7100</b>	Chrome	8Ga	16" Taper	N	N	N	Y	N	N	'88 - '96	N
<b>7108</b>	Chrome	8Ga	16" Taper	4 Rectangle	N	N	Y	N	N	'88 - '96	N



## FLC 112

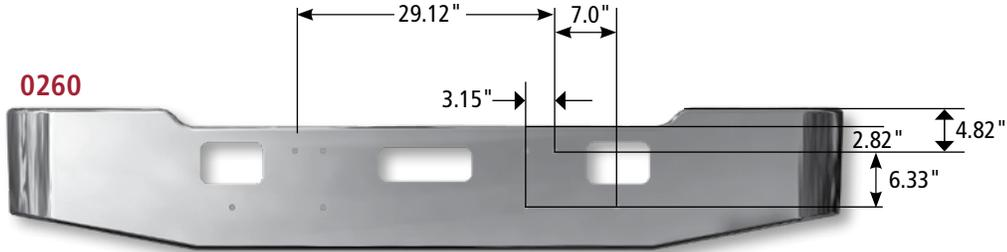

Freightliner® FLC-112

PART NO.	MATERIAL / FINISH	GAUGE / THICKNESS	STYLE	LIGHT	CENTER STEP	VENT	TOW	RADAR	EXCLUSIVE THROUGH OEM	YEAR	MOUNT / BRACKET
<b>0260</b>	Chrome	10Ga	16" Gullwing	N	Y	Y	Y	N	N	'86 - Newer	N
<b>0261</b>	Chrome	10Ga	16" Gullwing	2 Rectangle	Y	Y	Y	N	N	'86 - Newer	N

## FLD 112 / FLD 120 / FLD 120 SEVERE DUTY



Freightliner FLD 112 (SD)

PART NO.	MATERIAL / FINISH	GAUGE / THICKNESS	STYLE	LIGHT	CENTER STEP	VENT	TOW	RADAR	EXCLUSIVE THROUGH OEM	YEAR	MOUNT / BRACKET
<b>0232</b>	Chrome	10Ga	12" 17" Set Back	2 Rectangle	Y	N	Y	N	N	'92 - '07	N
<b>7233</b>	Chrome	7Ga	6" 12" Break Back	2 Rectangle	Y	N	Y	N	N	'92 - '07	N

## FLD 112 / FLD 120 / FLD 120 SEVERE DUTY cont.

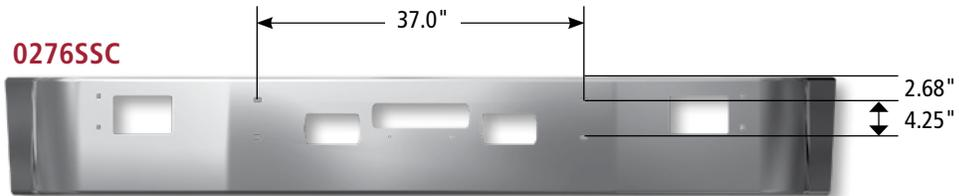

Freightliner® FLD 120

PART NO.	MATERIAL / FINISH	GAUGE / THICKNESS	STYLE	LIGHT	CENTER STEP	VENT	TOW	RADAR	EXCLUSIVE THROUGH OEM	YEAR	MOUNT / BRACKET
0275SSC <sup>1</sup>	AERO CLAD®	0.125"	13.5" Set Back	N	Y	N	Y	N	N	'89 - '04	Y
0276BX <sup>1</sup>	Steel Primed	10Ga	13.5" Set Back	2 Rectangle	Y	N	Y	N	N	'89 - '04	Y
0276SSC <sup>1</sup>	AERO CLAD	0.125"	13.5" Set Back	2 Rectangle	Y	N	Y	N	N	'89 - '04	Y
0277SSC <sup>1</sup>	AERO CLAD	0.125"	13.5" Set Back	N	Y	N	Y	N	N	'89 - '04	Y
0278SSC <sup>1</sup>	AERO CLAD	0.125"	13.5" Set Back	2 Rectangle	Y	N	Y	N	N	'89 - '04	Y
0279SSC <sup>1</sup>	AERO CLAD	0.125"	13.5" Set Back	N	Y	N	N	N	N	'89 - '04	Y

1. Braces and spacers included with bumper.

For models fitted with Perlex drive lights, use Freightliner back-up bar P/N A21-20133-003.

For models fitted with Marchel drive lights, use Freightliner back-up bar P/N A21-20133-000.

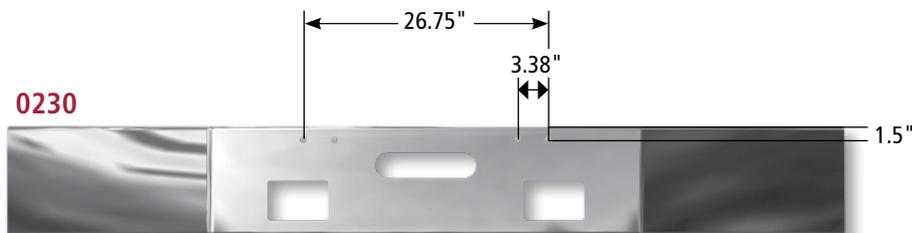

Fits FLD 120 Severe Duty

PART NO.	MATERIAL / FINISH	GAUGE / THICKNESS	STYLE	LIGHT	CENTER STEP	VENT	TOW	RADAR	EXCLUSIVE THROUGH OEM	YEAR	MOUNT / BRACKET
0230	Chrome	10Ga	12" 17" Set Back	2 Rectangle	Y	N	N	N	N	'86 - '08	N
7230	Chrome	7Ga	12" 17" Set Back	2 Rectangle	Y	N	N	N	N	'86 - '08	N
7240	Chrome	7Ga	12" 6" Break Back	2 Rectangle	Y	N	N	N	N	'86 - '09	N

## FLD-CLASSIC

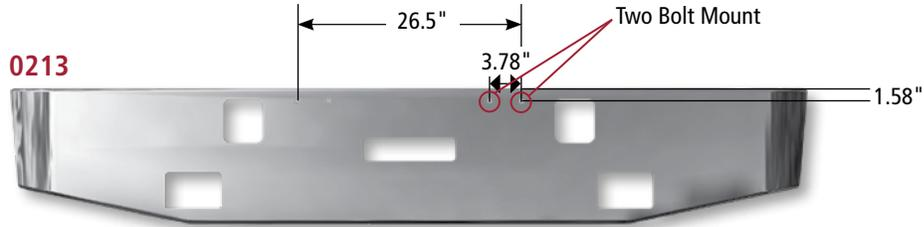

PART NO.	MATERIAL / FINISH	GAUGE / THICKNESS	STYLE	LIGHT	CENTER STEP	VENT	TOW	RADAR	EXCLUSIVE THROUGH OEM	YEAR	MOUNT / BRACKET
<b>0213</b>	Chrome	10Ga	16" Taper	2 Rectangle	N	N	Y	N	N	'02 - '10	N
<b>0213SQ</b>	Chrome	10Ga	18" Texas Square	2 Rectangle	N	N	Y	N	N	'02 - '10	N
<b>0213SSCSQ</b>	AERO CLAD®	0.125"	18" Texas Square	2 Rectangle	N	N	Y	N	N	'02 - '10	N
<b>7213SQ</b>	Chrome	7Ga	18" Texas Square	2 Rectangle	N	N	Y	N	N	'02 - '10	N
<b>7213SQ12</b>	Chrome	7Ga	12" Texas Square	2 Rectangle	N	N	Y	N	N	'02 - '10	N
<b>7213SSC</b>	AERO CLAD	0.160"	16" Taper	2 Rectangle	N	N	Y	N	N	'02 - '10	N
<b>0216</b>	Chrome	10Ga	16" Taper	N	N	N	Y	N	N	'02 - '10	N
<b>0216SSCSQ</b>	AERO CLAD	0.125"	18" Texas Square	N	N	N	Y	N	N	'02 - '10	N
<b>7216</b>	Chrome	7Ga	16" Taper	N	N	N	Y	N	N	'02 - '10	N
<b>7216SQ</b>	Chrome	7Ga	18" Texas Square	N	N	N	Y	N	N	'02 - '10	N
<b>7216SSC</b>	AERO CLAD	0.160"	16" Taper	N	N	N	Y	N	N	'02 - '10	N

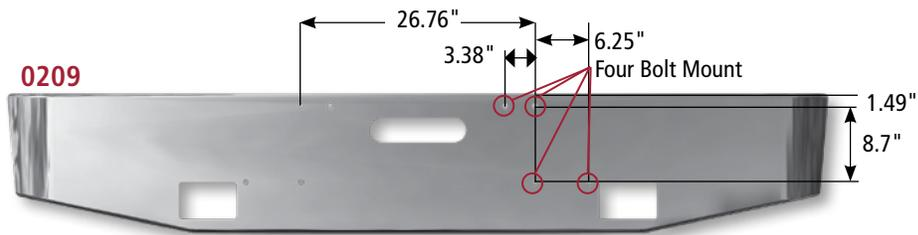

SEVERE DUTY

## FLD-CLASSIC cont.

PART NO.	MATERIAL / FINISH	GAUGE / THICKNESS	STYLE	LIGHT	CENTER STEP	VENT	TOW	RADAR	EXCLUSIVE THROUGH OEM	YEAR	MOUNT / BRACKET
0207	Chrome	10Ga	16" Taper	N	Y	N	Y	N	N	'84 - '02	N
0207SQ	Chrome	10Ga	18" Texas Square	N	Y	N	Y	N	N	'84 - '02	N
0209	Chrome	10Ga	16" Taper	2 Rectangle	N	N	Y	N	N	'84 - '02	N
0209NL	Chrome	10Ga	16" Taper	N	N	N	Y	N	N	'84 - '02	N
0209NLSQ	Chrome	10Ga	18" Texas Square	N	N	N	Y	N	N	'84 - '02	N
0223SQ	Chrome	10Ga	18" Texas Square	N	N	N	N	N	N	'84 - '02	N
0267SQ12	Chrome	10Ga	12" Texas Square	N	N	N	Y	N	N	'84 - '02	N
7209	Chrome	7Ga	16" Taper	2 Rectangle	N	N	Y	N	N	'84 - '02	N
7209NLSQ	Chrome	7Ga	18" Texas Square	N	N	N	Y	N	N	'84 - '02	N
7250SSC	AERO CLAD	0.160"	16" Taper	2 Rectangle	N	N	Y	N	N	'84 - '02	N

## 122SD

PART NO.	MATERIAL / FINISH	GAUGE / THICKNESS	STYLE	LIGHT	CENTER STEP	VENT	TOW	RADAR	EXCLUSIVE THROUGH OEM	YEAR	MOUNT / BRACKET
7299SSC	AERO CLAD	0.160"	12" Set Forward	4 Rectangle	N	N	Y	N	N	'13 - Newer	N
7299NLSSC	AERO CLAD	0.160"	12" Set Forward	N	N	N	Y	N	N	'13 - Newer	N



## BUSINESS CLASS



PART NO.	MODEL	LEG	DIMENSION
<b>0296SSC</b>	FL50, 60, 70, 80, 106	A	14.2"
<b>0295SSC</b>	FL50, 60, 70, 80, 106	B	19.9"



Freightliner® stainless steel clad aluminum fits Business Class

PART NO.	MATERIAL / FINISH	GAUGE / THICKNESS	STYLE	LIGHT	CENTER STEP	VENT	TOW	RADAR	EXCLUSIVE THROUGH OEM	YEAR	MOUNT / BRACKET
<b>0295SSC</b>	AERO CLAD®	0.125"	11" Set Back	2 Rectangle	Y	N	N	N	N	'97 - '04	N
<b>0296SSC</b>	AERO CLAD	0.125"	11" Set Back	2 Rectangle	Y	N	N	N	N	'97 - '04	N

## CENTURY CLASS



Freightliner Century Class stainless steel clad aluminum — Includes brackets (Installed)<sup>1</sup>

PART NO.	MATERIAL / FINISH	GAUGE / THICKNESS	STYLE	LIGHT	CENTER STEP	VENT	TOW	RADAR	EXCLUSIVE THROUGH OEM	YEAR	MOUNT / BRACKET
<b>0290SSC<sup>1</sup></b>	AERO CLAD	0.125"	14.5" Set Back	N	Y	N	Y	N	N	'96 - '03	Y
<b>0291SSC</b>	AERO CLAD	0.125"	14.5" Set Back	N	Y	N	Y	N	N	'04 - '07	Y

**1. OEM Required hardware to install bumper on '96 truck model (only):**  
 Mounting bracket (P/N: A21-25693-000 LH & A21-25693-001 RH) and spacer (2 required, P/N: 23-11427-038) available from your Freightliner dealer. Drill 14mm hole in top mounting bracket for pre-1997 Century Class.

## COLUMBIA



Freightliner® Columbia stainless steel clad aluminum

PART NO.	LEG	DIMENSION
<b>0292SSC<sup>1</sup></b>	A	25.15"
<b>0293SSC<sup>2</sup></b>	B	28.34"

1. When replacing factory bumper you must refer to Freightliner Bill of Material T80133.
2. When replacing factory bumper you must refer to Freightliner Bill of Material T80132.

PART NO.	MATERIAL / FINISH	GAUGE / THICKNESS	STYLE	LIGHT	CENTER STEP	VENT	TOW	RADAR	EXCLUSIVE THROUGH OEM	YEAR	MOUNT / BRACKET
<b>0292SSC</b>	AERO CLAD®	0.125"	14.5" Set Back	N	Y	N	Y	N	N	'04 -'07	N
<b>0293SSC</b>	AERO CLAD	0.125"	14.5" Set Back	N	Y	N	Y	N	N	Prior to '04	N

## New CASCADIA®

### **H AERO CLAD®** Stainless Steel Clad Aluminum Bumper

#### Features and Benefits

- Lightweight design
- Easy installation to factory mounts
- Durable, bright mirrored finish
- 10 times thicker finish than chrome
- Resists corrosion, cracking, pitting, peeling and fading
- Quality, American made product
- Ground clearance – 5.5 inches higher relative to OE Aero Package
- Minor abrasions can be buffed
- Full 5-year limited warranty\*



\*Contact your local Hendrickson representative for complete warranty terms, conditions and limitations.

PART NO.	MATERIAL / FINISH	GAUGE / THICKNESS	STYLE	LIGHT	CENTER STEP	VENT	TOW	RADAR COMPATIBLE <sup>1</sup>	EXCLUSIVE THROUGH OEM	YEAR	MOUNT / BRACKET <sup>2</sup>	LICENSE PLATE HOLES
<b>FF2200NLSSC</b>	AERO CLAD®	0.125"	Closed End	N	N	Y	Y	Y	Y	2018 - Newer	N	Y
<b>FF2200SSC</b>	AERO CLAD	0.125"	Closed End	Y	N	Y	Y	Y	Y	2018 - Newer	N	Y

1. Contact local dealer to discuss radar options.

2. Mounting brackets, associated hardware and installation instructions are available from your Freightliner dealer.

#### OEM Bracket Numbers - Sold through OEM

DESCRIPTION	DAIMLER P/N	REQUIREMENTS FOR DAIMLER BUMPER			
		21-28840-004	21-28840-005	21-28840-006	21-28840-007
Mounting Bracket LH / RH	21-28841-006 / -007	X	X	X	X
Back Reinforcement Bracket LH / RH	21-29016-002 / -003	X	X	X	X
Bracket Frame LH / RH	A21-29018-000 / -001	X	X	X	X
Fog Lamp Bracket LH / RH	66-05687-000 / -001		X		X
Fog Lamp Bracket LH / RH	66-05812-000		X		X
WABCO® OnGuard Radar Mounting Bracket	66-06125-000	*	*	*	*
Detroit Assurance Radar Mounting Bracket	66-06125-001	*	*	*	*
Non Radar Screen	21-28972-000	*	*	*	*
Radar Compatible Screens LH / RH	21-28972-001 / -002	*	*	*	*
Radar Cover for AERO CLAD Bumper	66-06345-000	*	*	*	*
Screen Mounting Brackets	21-29203-000	X	X	X	X

\* Conversion from an OEM plastic bumper to AERO CLAD requires the corresponding screens, four screen mounting brackets and radar system mount bracket, if equipped. Mounting brackets, screens, associated hardware and installation instructions are available from your Freightliner dealer.

## Classic CASCADIA®

### **AERO CLAD®**

Stainless Steel Clad Aluminum Bumper

#### Features and Benefits

- Durable, bright mirrored finish
- 10 times thicker finish than chrome
- Resists corrosion, cracking, pitting, peeling and fading
- Increased ground clearance
- Lightweight design – no adverse effect on fuel consumption
- Minor abrasions can be buffed
- Full 5-year limited warranty\*

\*Contact your local Hendrickson representative for complete warranty terms, conditions and limitations.



PART NO.	MATERIAL / FINISH	GAUGE / THICKNESS	STYLE	LIGHT	CENTER STEP	VENT	TOW	RADAR COMPATIBLE <sup>3</sup>	EXCLUSIVE THROUGH OEM	YEAR	MOUNT / BRACKET <sup>4</sup>	LICENSE PLATE HOLES
<b>0256NLSSC<sup>1</sup></b>	AERO CLAD®	0.125"	15" Closed End	N	Y	Y	Y	Y	N	'08 - Newer	Y	Y
<b>0256SSC<sup>1</sup></b>	AERO CLAD	0.125"	15" Closed End	2 Oval	Y	Y	Y	Y	N	'08 - Newer	Y	Y
<b>0257NLSSC<sup>2</sup></b>	AERO CLAD	0.125"	15" Closed End	N	Y	Y	Y	Y	N	'08 - Newer	Y	Y
<b>0257SSC<sup>2</sup></b>	AERO CLAD	0.125"	15" Closed End	2 Oval	Y	Y	Y	Y	N	'08 - Newer	Y	Y
<b>FF02C1SSC<sup>1</sup></b>	AERO CLAD	0.125"	15" Closed End	2 Oval	Y	Y	Y	Y	Y	'08 - Newer	Y	N
<b>FF02C1NLSSC<sup>1</sup></b>	AERO CLAD	0.125"	15" Closed End	N	Y	Y	Y	Y	Y	'08 - Newer	Y	N
<b>FF02C2SSC<sup>2</sup></b>	AERO CLAD	0.125"	15" Closed End	2 Oval	Y	Y	Y	Y	Y	'08 - Newer	Y	N
<b>FF02C2NLSSC<sup>2</sup></b>	AERO CLAD	0.125"	15" Closed End	N	Y	Y	Y	Y	Y	'08 - Newer	Y	N

1. Kit includes hardware needed to replace OEM plastic bumper and includes top fillers.
2. Assembly when replacing existing AERO CLAD® bumper. Top fillers sold separately.
3. Contact your local dealer to discuss radar options.
4. Classic Cascadia trucks configured with a large capacity radiator, require mounting brackets A21-28537-000 and A21-28537-001. Available from your Freightliner dealer.

## CASCADIA TRIM OPTIONS

### Top Filler Replacements

PART NO.	MATERIAL / FINISH	GAUGE / THICKNESS	STYLE	LIGHT	CENTER STEP	VENT	TOW	RADAR	EXCLUSIVE THROUGH OEM	YEAR	MOUNT / BRACKET
<b>0256TFLK</b>	TPO	–	Top Fillers	–	–	–	–	–	N	'08 - Newer	–
<b>0256TFRK</b>	TPO	–	Top Fillers	–	–	–	–	–	N	'08 - Newer	–

## M2

### **H** AERO CLAD®

Stainless Steel Clad Aluminum Bumper

#### Features and Benefits

- Lightweight design
- Easy installation to factory mounts
- Durable, bright mirrored finish
- 10 times thicker finish than chrome
- Resists corrosion, cracking, pitting, peeling and fading
- Quality, American made product
- Minor abrasions can be buffed
- Full 5-year limited warranty\*



*\*Contact your local Hendrickson representative for complete warranty terms, conditions and limitations.*

PART NO.	MATERIAL / FINISH	GAUGE / THICKNESS	STYLE	LIGHT	CENTER STEP	VENT	TOW	EXCLUSIVE THROUGH OEM	YEAR	MOUNT / BRACKET	LICENSE PLATE HOLES
<b>FF5212SSC</b>	AERO CLAD®	0.160"	14" Set Back	N	N	Y	Y	Y	'12 - Newer	Y	Y



# INTERNATIONAL®

HX™

## **H AERO CLAD®** Stainless Steel Clad Aluminum Bumper

### Features and Benefits

- Durable, bright mirrored finish
- 10 times thicker finish than chrome
- Resists corrosion, cracking, pitting, peeling and fading
- High ground clearance
- Lightweight design
- Minor abrasions can be buffed
- Full 5-year limited warranty\*

*\* Contact your local Hendrickson representative for complete warranty terms, conditions and limitations.*



PART NO.	MATERIAL / FINISH	GAUGE / THICKNESS	STYLE	LIGHT	CENTER TOW	TOW	EXCLUSIVE THROUGH OEM	YEAR	TIRE SHIELDS
<b>AM5433SSC</b>	AERO CLAD®	0.160"	12" Set Back	Y	N	Y	Y	All	N
<b>AM54C3NLSSC</b>	AERO CLAD	0.160"	12" Set Back	N	N	Y	Y	All	N
<b>AM54C4SSC</b>	AERO CLAD	0.160"	12" Set Back	Y	Y	Y	Y	All	N
<b>AM54C4NLSSC</b>	AERO CLAD	0.160"	12" Set Back	N	Y	Y	Y	All	N
<b>24C1SSC</b>	AERO CLAD	0.125"	Set Forward 18" Texas Square	Y	N	Y	N	All	Y
<b>24C1NLSSC</b>	AERO CLAD	0.125"	Set Forward 18" Texas Square	N	N	Y	N	All	Y
<b>24C2SSC</b>	AERO CLAD	0.125"	Set Forward 18" Texas Square	Y	Y	Y	N	All	Y
<b>24C2NLSSC</b>	AERO CLAD	0.125"	Set Forward 18" Texas Square	N	Y	Y	N	All	Y
<b>54C5SSC</b>	AERO CLAD	0.160"	Set Forward 16" Taper	Y	N	Y	N	All	N
<b>54C5NLSSC</b>	AERO CLAD	0.160"	Set Forward 16" Taper	N	N	Y	N	All	N
<b>54C6SSC</b>	AERO CLAD	0.160"	Set Forward 16" Taper	Y	Y	Y	N	All	N
<b>54C6NLSSC</b>	AERO CLAD	0.160"	Set Forward 16" Taper	N	Y	Y	N	All	N



# INTERNATIONAL®

LT®

## **H AERO CLAD®** Stainless Steel Clad Aluminum Bumper

### Features and Benefits

- Durable, bright mirrored finish
- 10 times thicker finish than chrome
- Resists corrosion, cracking, pitting, peeling and fading
- High ground clearance
- Lightweight design
- Minor abrasions can be buffed
- Includes rock screens
- Includes plastic top fillers
- Full 5-year limited warranty\*

*\*Contact your local Hendrickson representative for complete warranty terms, conditions and limitations.*



PART NO.	MATERIAL / FINISH	GAUGE / THICKNESS	LIGHT	CENTER STEP	VENT	TOW	RADAR	EXCLUSIVE THROUGH OEM	YEAR	MOUNT	BRACKET
<b>AM0453SSC</b>	AERO CLAD®	0.125"	Y	N	Y	Y	N	Y	'17 - Newer	Fixed Mount	None
<b>AM0453VSSC</b>	AERO CLAD	0.125"	Y	N	Y	Y	Y	Y	'17 - Newer	Fixed Mount	None
<b>AM0460BKTK</b>	Bracket Mounting Kit							Y	Feb. '14 - Newer	Fixed Mount	Brackets Only

**NOTE:** Converting OEM Composite Bumper to AM0453SSC requires bracket kit AM0460BKTK and fog lights 3815291C91 (clear) or 3803013C91 (Halogen).

### Top Filler Replacements

PART NO.	MATERIAL / FINISH	GAUGE / THICKNESS	STYLE	LIGHT	CENTER STEP	VENT	TOW	RADAR	EXCLUSIVE THROUGH OEM	YEAR
<b>AM0453TFK</b>	TPO	–	Top Fillers	–	–	–	–	–	Y	'17 - Newer

**NOTE:** Top filler kit includes both driver and passenger side replacements.



# INTERNATIONAL®

## PROSTAR®

### **H** AERO CLAD® Stainless Steel Clad Aluminum Bumper

#### Features and Benefits

- Durable, bright mirrored finish
- 10 times thicker finish than chrome
- Resists corrosion, cracking, pitting, peeling and fading
- High ground clearance
- Lightweight design
- Minor abrasions can be buffed
- Includes rock screens
- Includes plastic top fillers
- Full 5-year limited warranty\*

\* Contact your local Hendrickson representative for complete warranty terms, conditions and limitations.



PART NO.	MATERIAL / FINISH	GAUGE / THICKNESS	LIGHT	CENTER STEP	VENT	TOW	RADAR	EXCLUSIVE THROUGH OEM	YEAR	MOUNT	MOUNT / BRACKET
<b>AM0449SSC</b>	AERO CLAD®	0.125"	Y	N	Y	Y	N	Y	'09 - Older	Tilt Mount	Brackets Included*
<b>AM0450SSC</b>	AERO CLAD	0.125"	Y	N	Y	Y	N	Y	'10 - Newer	Fixed Mount	None
<b>AM0450VSSC</b>	AERO CLAD	0.125"	Y	N	Y	Y	Y	Y	'10 - Newer	Fixed Mount	None
<b>AM0451SSC</b>	AERO CLAD	0.125"	Y	N	Y	Y	N	Y	All	Tilt Mount	Brackets Included
<b>AM0460SSCAK</b>	AERO CLAD	0.125"	Y	N	Y	Y	N	Y	'14 - Newer	Fixed Mount	Brackets Included
<b>AM0460BKTK</b>	Bracket Mounting Kit							-	'14 - Newer	Fixed Mount	Brackets Only

NOTE: Converting OEM Fixed Mount Bumper with AM0451SSC will require two additional brackets through OEM.

\* Does not include tilt and latch brackets

#### Top Filler Replacements

PART NO.	MATERIAL / FINISH	GAUGE / THICKNESS	STYLE	LIGHT	CENTER STEP	VENT	TOW	RADAR	EXCLUSIVE THROUGH OEM	YEAR
<b>AM0449TFK</b>	TPO	-	Top Fillers	-	-	-	-	-	Y	All

NOTE: Top filler kit includes both driver and passenger side replacements.



# INTERNATIONAL®

## LONESTAR®

### **H** AERO CLAD® Stainless Steel Clad Aluminum Bumper

#### Features and Benefits

- Durable, bright mirrored finish
- 10 times thicker finish than chrome
- Resists corrosion, cracking, pitting, peeling and fading
- Lightweight design
- Minor abrasions can be buffed
- Full 5-year limited warranty\*

\*Contact your local Hendrickson representative for complete warranty terms, conditions and limitations.



PART NO.	MATERIAL / FINISH	GAUGE / THICKNESS	LIGHT	CENTER STEP	VENT	TOW	RADAR	EXCLUSIVE THROUGH OEM	YEAR	MOUNT / BRACKET
<b>AM2461SSC</b>	AERO CLAD®	0.125"	Y	N	Y	Y	Y	Y	'08 - Newer	Y
<b>AM2460SSC</b>	AERO CLAD	0.125"	Y	N	Y	Y	N	Y	'08 - Newer	Y

NOTE: Includes primer coated top trim pieces, lights, wiring harness, rock screen and hardware.

2008 to 2016 models requires mounting braces 4057544C3 and 4057545C3. Not retrofittable to the special edition Harley Davidson® model.

## Rock Guard

PART NO.	MATERIAL / FINISH	GAUGE / THICKNESS	LIGHT	CENTER STEP	VENT	TOW	RADAR	EXCLUSIVE THROUGH OEM	YEAR
<b>602300S</b>	Stainless Steel	0.06"	N/A	N/A	Y	N/A	Y	Y	'17 - Newer
<b>602256S</b>	Stainless Steel	0.06"	N/A	N/A	Y	N/A	N	Y	'17 - Newer

#### Top Filler Replacements

PART NO.	MATERIAL / FINISH	GAUGE / THICKNESS	STYLE	LIGHT	CENTER STEP	VENT	TOW	RADAR	MODEL	EXCLUSIVE THROUGH OEM	YEAR	MOUNT / BRACKET
<b>602209KXS</b>	TPO	—	Top Fillers	—	—	—	—	—	LoneStar®	Y	All	—

NOTE: Top filler kits include both driver and passenger side replacements and associated mounting hardware.

# INTERNATIONAL®

MV™

## **H** AERO CLAD®

Stainless Steel Clad Aluminum Bumper

### Features and Benefits

- Lightweight design
- Easy installation to factory mounts
- Durable, bright mirrored finish
- Resists corrosion, cracking, pitting, peeling and fading
- Quality, American made product
- Minor abrasions can be buffed
- Full 5-year limited warranty\*

\*Contact your local Hendrickson representative for complete warranty terms, conditions and limitations.



PART NO.	MATERIAL	GAUGE/THICKNESS	STYLE	LIGHT	CENTER STEP	VENT	TOW	RADAR	EXCLUSIVE	YEAR	MOUNT/BRACKETS	LICENSE PLATE HOLES
<b>24D7SSCA</b>	AERO CLAD	.125"	13.5" Open End	N	N	Y	Y	Y	N	15' - Newer	Y	Y

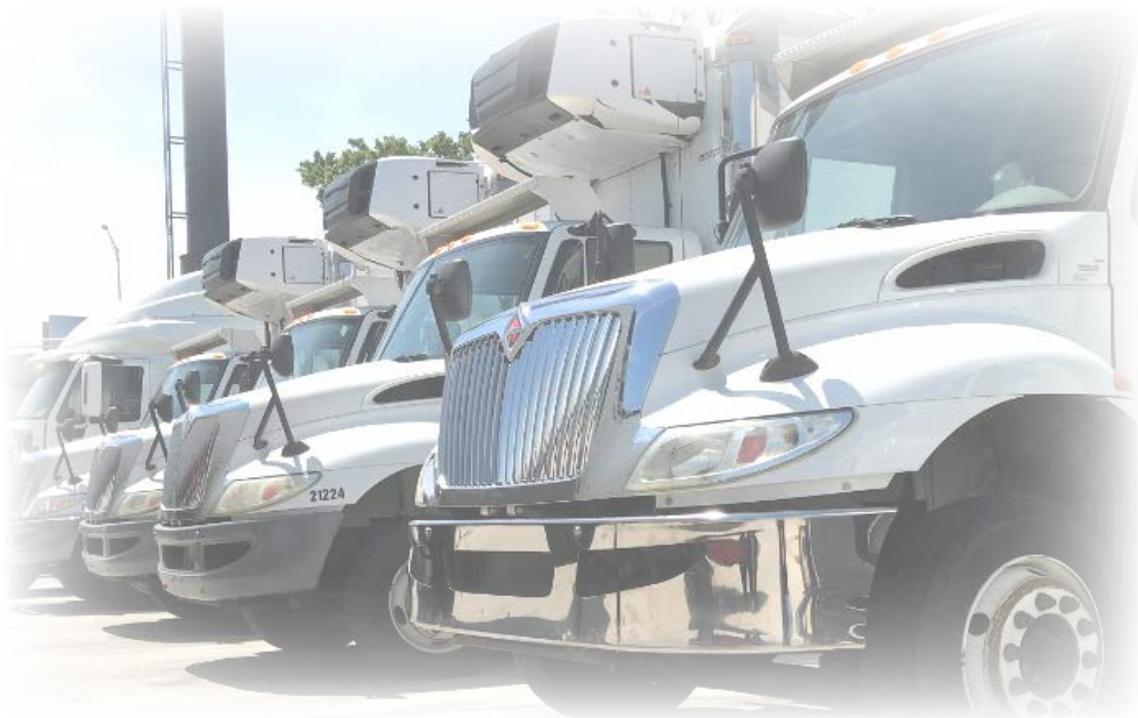

# INTERNATIONAL®

## VISION 98 - 9200i / 9400i



PART NO.	MATERIAL / FINISH	GAUGE / THICKNESS	STYLE	LIGHT	CENTER STEP	VENT	TOW	RADAR	EXCLUSIVE THROUGH OEM	YEAR	MOUNT / BRACKET
<b>AM0442SSC</b>	AERO CLAD®	0.125"	12" Set Back	N	N	Y	Y	Y	N	'97 - Newer	N
<b>AM0490SSC</b>	AERO CLAD	0.125"	12" Set Back	N	N	Y	Y	N	N	'97 - Newer	N
<b>AM0490X</b>	Aluminum Primed	0.179"	12" Set Back	N	N	Y	Y	N	N	'97 - Newer	N

## 5000

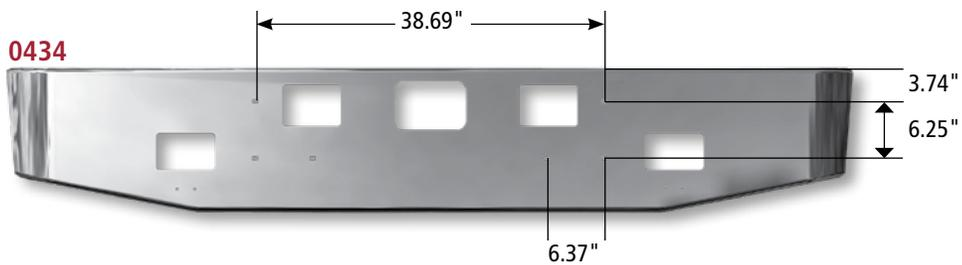

5900 Conventional Series

PART NO.	MATERIAL / FINISH	GAUGE / THICKNESS	STYLE	LIGHT	CENTER STEP	VENT	TOW	RADAR	EXCLUSIVE THROUGH OEM	YEAR	MOUNT / BRACKET
<b>0434</b>	Chrome	10Ga	16" Taper	2 Rectangle	Y	N	Y	N	N	—	N
<b>0434SQ</b>	Chrome	0.122"	18" Texas Square	2 Rectangle	Y	N	Y	N	N	—	N



# INTERNATIONAL®



## 9000, 9900i, 9670 COE and 9370

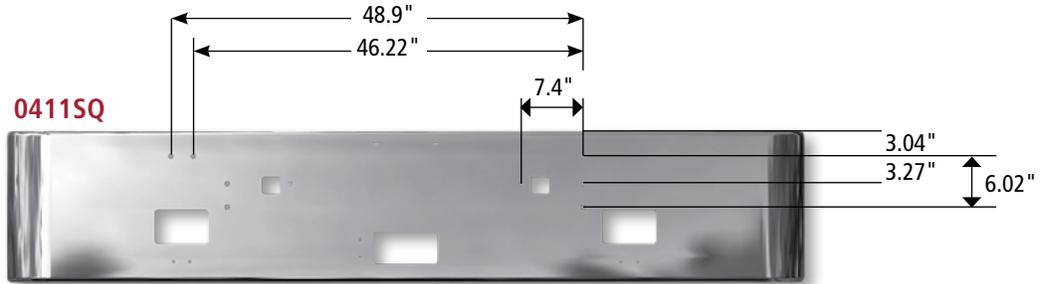

9370 Conventional Series

PART NO.	MATERIAL / FINISH	GAUGE / THICKNESS	STYLE	LIGHT	CENTER STEP	VENT	TOW	RADAR	EXCLUSIVE THROUGH OEM	YEAR	MOUNT / BRACKET
<b>0410</b>	Chrome	10Ga	16" Taper	N	Y	N	Y	N	N	—	N
<b>0410SQ</b>	Chrome	0.125"	18" Texas Square	N	Y	N	Y	N	N	—	N
<b>0411</b>	Chrome	10Ga	16" Taper	2 Rectangle	Y	N	Y	N	N	—	N
<b>0411SQ</b>	Chrome	0.125"	18" Texas Square	2 Rectangle	Y	N	Y	N	N	—	N
<b>0416SQ</b>	Chrome	0.125"	18" Texas Square	N	N	N	Y	N	N	—	N
<b>0417SQ</b>	Chrome	10Ga	18" Texas Square	9 Oval	N	N	Y	N	N	—	N



## 9900i CONVENTIONAL

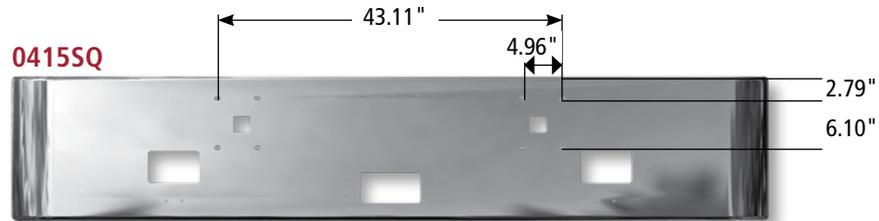

PART NO.	MATERIAL / FINISH	GAUGE / THICKNESS	STYLE	LIGHT	CENTER STEP	VENT	TOW	RADAR	EXCLUSIVE THROUGH OEM	YEAR	MOUNT / BRACKET
<b>0415</b>	Chrome	10Ga	16" Taper	2 Rectangle	Y	N	Y	N	N	'96 - Newer	N
<b>0415NL</b>	Chrome	10Ga	16" Taper	N	Y	N	Y	N	N	'96 - Newer	N
<b>0415NLSQ</b>	Chrome	0.125"	18" Texas Square	N	Y	N	Y	N	N	'96 - Newer	N
<b>0415SQ</b>	Chrome	0.125"	18" Texas Square	2 Rectangle	Y	N	Y	N	N	'96 - Newer	N
<b>0415SSCSQ*</b>	AERO CLAD®	0.125"	18" Texas Square	2 Rectangle	Y	N	Y	N	N	'96 - Newer	N
<b>0425SQ</b>	Chrome	0.125"	18" Texas Square	N	N	N	Y	N	N	'96 - Newer	N

**NOTE:** AERO CLAD® Texas Square (0415SSCSQ) requires separate purchase of stiffener brackets P/N 3523291C1 LH and 3523292C1 RH.  
\*Fits 1996 year and newer.

## 9200 / 9400

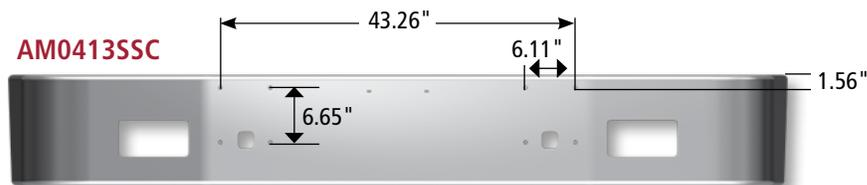

PART NO.	MATERIAL / FINISH	GAUGE / THICKNESS	STYLE	LIGHT	CENTER STEP	VENT	TOW	RADAR	EXCLUSIVE THROUGH OEM	YEAR	MOUNT / BRACKET
<b>AM0413SSC</b>	AERO CLAD®	0.125"	13.5" Set Back 9200 Series	2 Rectangle	N	N	Y	N	N	'96 - Newer	N
<b>AM0414SSC</b>	AERO CLAD	0.125"	13.5" Set Back 9400 Series	2 Rectangle	N	N	Y	N	N	'96 - Newer	N



## 7000 / WORKSTAR

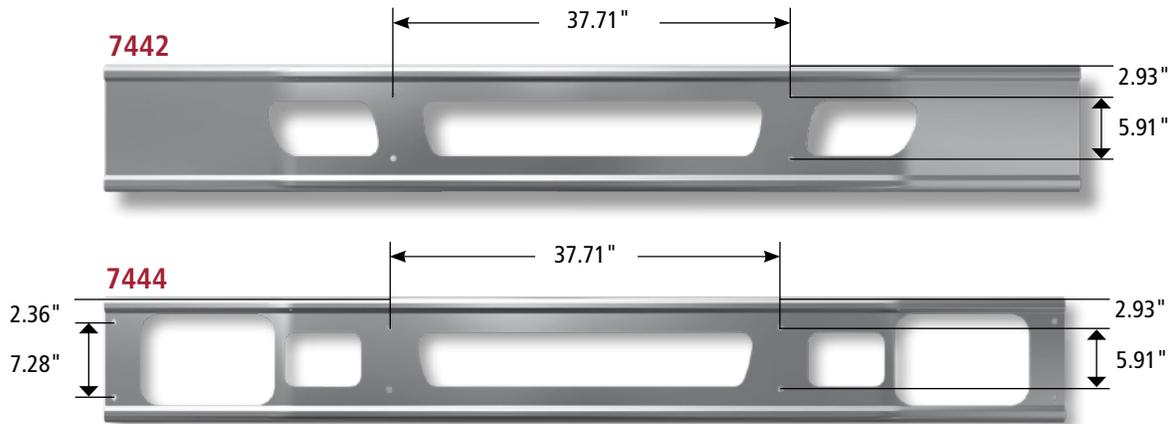

PART NO.	MATERIAL / FINISH	GAUGE / THICKNESS	STYLE	LIGHT	CENTER STEP	VENT	TOW	RADAR	EXCLUSIVE THROUGH OEM	YEAR	MOUNT / BRACKET
<b>7442BX</b>	Steel Primed	7Ga	12" Set Forward	2 Rectangle	N	Y	Y	N	N	A	N
<b>7442</b>	Chrome	7Ga	12" Set Forward	2 Rectangle	N	Y	Y	N	N	A	N
<b>7442SSC</b>	AERO CLAD®	0.160"	12" Set Forward	2 Rectangle	N	Y	Y	N	N	A	N
<b>7444BX</b>	Steel Primed	7Ga	12" Set Forward	2 Rectangle	N	Y	Y	N	N	A	N
<b>7444</b>	Chrome	7Ga	12" Set Forward	2 Rectangle	N	Y	Y	N	N	A	N
<b>7444SSC</b>	AERO CLAD	0.160"	12" Set Forward	2 Rectangle	N	Y	Y	N	N	A	N
<b>7445BX</b>	Steel Primed	7Ga	12" Set Back	2 Rectangle	N	Y	Y	N	N	A	N
<b>7445</b>	Chrome	7Ga	12" Set Back	2 Rectangle	N	Y	Y	N	N	A	N
<b>7445SSC</b>	AERO CLAD	0.160"	12" Set Back	2 Rectangle	N	Y	Y	N	N	A	N
<b>7467BX</b>	Steel Primed	7Ga	12" Set Forward	2 Rectangle	N	Y	Y	N	Y	A	N
<b>7467</b>	Chrome	7Ga	12" Set Forward	2 Rectangle	N	Y	Y	N	Y	A	N
<b>7468BX</b>	Steel Primed	7Ga	12" Set Back	2 Rectangle	N	Y	Y	N	Y	B	N
<b>7468</b>	Chrome	7Ga	12" Set Back	2 Rectangle	N	Y	Y	N	Y	B	N
<b>7469SSC</b>	AERO CLAD	0.160"	12" Set Back	2 Rectangle	N	Y	Y	N	Y	C	N

APPLICATION GUIDELINES		
A	B	C
<b>7300</b> – Oct. 2001 and Newer	<b>7300</b> – Oct. 2001 and Newer	<b>7400</b> – July 2001 and Newer
<b>7400</b> – July 2001 and Newer	<b>7400</b> – July 2001 and Newer	<b>7500</b> – July 2001 and Newer
<b>7500</b> – July 2001 and Newer	<b>7500</b> – July 2001 and Newer	<b>7600</b> – April 2002 and Newer
<b>7600</b> – April 2002 and Newer	<b>7600</b> – April 2002 and Newer	
	<b>7700</b> – Dec. 2003 and Newer	



## T300



PART NO.	MATERIAL / FINISH	GAUGE / THICKNESS	STYLE	LIGHT	CENTER STEP	VENT	TOW	RADAR	EXCLUSIVE THROUGH OEM	YEAR	MOUNT / BRACKET
<b>0588SSC</b>	AERO CLAD®	0.125"	12" Set Back	N	Y	N	Y	N	N	All	N
<b>0589SSC</b>	AERO CLAD	0.125"	12" Set Back	N	N	N	Y	N	N	All	N
<b>7588BX</b>	Steel Primed	7Ga	12" Set Back	N	Y	N	Y	N	N	All	N
<b>7589BX</b>	Steel Primed	7Ga	12" Set Back	N	N	N	Y	N	N	All	N

## T600



PART NO.	MATERIAL / FINISH	GAUGE / THICKNESS	STYLE	LIGHT	CENTER STEP	VENT	TOW	RADAR	EXCLUSIVE THROUGH OEM	YEAR	MOUNT / BRACKET
<b>0561BX</b>	Steel Primed	10Ga	14" Set Back	N	Y	Y	Y	Y	N	'85 - '07	N
<b>0562SSC</b>	AERO CLAD	0.125"	14" Set Back	N	Y	Y	Y	Y	N	'85 - '07	N



## T680

### **H**AERO CLAD®

Stainless Steel Clad Aluminum Bumper

#### Features and Benefits

- Lightweight design
- Easy installation to factory mounts
- Durable, bright mirrored finish
- 10 times thicker finish than chrome
- Resists corrosion, cracking, pitting, peeling and fading
- 65 pounds lighter than OEM bumper
- Quality American made product
- Improved ground clearance – up to 4 inches
- Minor abrasions can be buffed
- Full 5-year limited warranty\*



\* Contact your local Hendrickson representative for complete warranty terms, conditions and limitations.

PART NO.	MATERIAL / FINISH	GAUGE / THICKNESS	STYLE	LIGHT	CENTER STEP	VENT	TOW	RADAR	EXCLUSIVE THROUGH OEM	YEAR	MOUNT / BRACKET
<b>25S0NLSSCA</b>	AERO CLAD®	0.125"	10" Set Back	N	N	N	Y	N	N	ALL	Y
<b>25S0NLVSSCA</b>	AERO CLAD	0.125"	10" Set Back	N	N	N	Y	Y	N	ALL	Y
<b>25S0SSCA</b>	AERO CLAD	0.125 in.	10 in. Set Back	Y	N	N	Y	N	N	ALL	Y
<b>25S0VSSCA</b>	AERO CLAD	0.125 in.	10 in. Set Back	Y	N	N	Y	Y	N	ALL	Y

Note: All part numbers include plastic fillers

## Ground clearance: OEM bumper compared to AERO CLAD



Note: Hendrickson AERO CLAD bumper improves ground clearance by 3.75 inches when compared to the OEM bumper

\*\*25S0NLVSSCA shown above

## T800 / T880

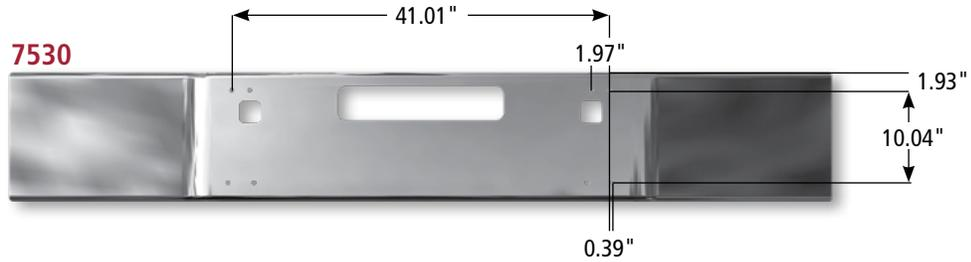

PART NO.	MATERIAL / FINISH	GAUGE / THICKNESS	STYLE	LIGHT	CENTER STEP	VENT	TOW	RADAR	EXCLUSIVE THROUGH OEM	YEAR	MOUNT / BRACKET
<b>0530NT</b>	Chrome	10Ga	14" Open End	N	N	Y	N	N	N	'86 - '04	N
<b>0530</b>	Chrome	10Ga	14" Open End	N	N	Y	Y	N	N	'86 - '04	N
<b>7530</b>	Chrome	7Ga	14" Open End	N	N	Y	Y	N	N	'86 - '04	N
<b>7530BX</b>	Steel Primed	7Ga	14" Open End	N	N	Y	Y	N	N	'86 - '04	N
<b>5530SSC</b>	AERO CLAD®	0.160"	14" Open End	N	N	Y	Y	N	N	'86 - '04	N
<b>7531</b>	Chrome	7Ga	14" Open End	2 Rectangle	N	Y	Y	N	N	'86 - '04	N
<b>5531SSC</b>	AERO CLAD	0.160"	14" Open End	2 Rectangle	N	Y	Y	N	N	'86 - '04	N
<b>7540</b>	Chrome	7Ga	14" Taper	N	N	Y	Y	N	N	'86 - '04	N
<b>7542<sup>1</sup></b>	Chrome	7Ga	14" Taper	N	N	Y	Y	N	N	'86 - '04	N
<b>7543</b>	Chrome	7Ga	14" Taper	2 Rectangle	N	Y	Y	N	N	'86 - '04	N
<b>0544<sup>1</sup></b>	Chrome	10Ga	14" Taper	2 Rectangle	N	Y	Y	N	N	'86 - '04	N

Conventional with 7-inch break-back

1. Surface Mount Hitch



## T800 / T880 cont.

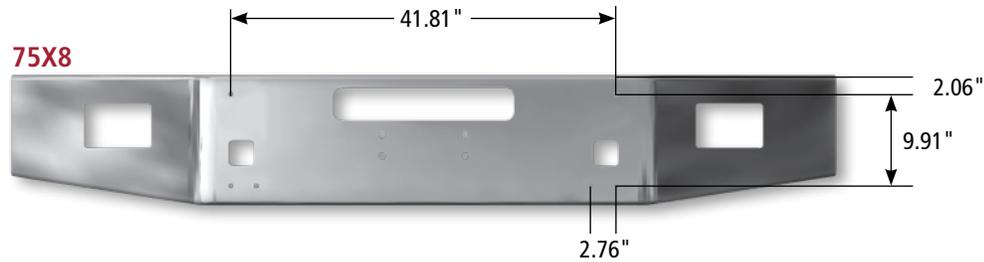

PART NO.	MATERIAL / FINISH	GAUGE / THICKNESS	STYLE	LIGHT	CENTER STEP	VENT	TOW	RADAR	EXCLUSIVE THROUGH OEM	YEAR	MOUNT / BRACKET
<b>55X0NLSSC</b>	AERO CLAD®	0.160"	14" Open End	N	N	Y	Y	N	Y	'04 - Newer	N
<b>55X0SSC</b>	AERO CLAD	0.160"	14" Open End	2 Rectangle	N	Y	Y	N	Y	'04 - Newer	N
<b>75X0</b>	Chrome	7Ga	14" Open End	2 Rectangle	N	Y	Y	N	Y	'04 - Newer	N
<b>75X0R</b>	Chrome	7Ga	14" Open End	2 Round	N	Y	Y	N	N	'04 - Newer	N
<b>75X0NL</b>	Chrome	7Ga	14" Open End	N	N	Y	Y	N	Y	'04 - Newer	N
<b>75X2NLPOL</b>	Polished Aluminum	0.25"	14" Taper	N	N	Y	Y	N	N	'04 - Newer	N
<b>75X2POL</b>	Polished Aluminum	0.25"	14" Taper	2 Rectangle	N	Y	Y	N	N	'04 - Newer	N
<b>75X2</b>	Chrome	7Ga	14" Taper	2 Rectangle	N	Y	Y	N	Y	'04 - Newer	N
<b>75X2NL</b>	Chrome	7Ga	14" Taper	N	N	Y	Y	N	Y	'04 - Newer	N
<b>75X2RS</b>	Chrome	7Ga	14" Taper	2 Rectangle	N	Y	Y	N	Y	'04 - Newer	N
<b>75X6<sup>1</sup></b>	Chrome	7Ga	14" Taper	2 Rectangle	N	Y	Y	N	Y	'04 - Newer	N
<b>75X8<sup>2</sup></b>	Chrome	7Ga	14" Taper	2 Rectangle	N	Y	Y	N	N	'04 - Newer	N
<b>75X6NL<sup>1</sup></b>	Chrome	7Ga	14" Taper	N	N	Y	Y	N	Y	'04 - Newer	N
<b>05X8<sup>2</sup></b>	Chrome	10Ga	14" Taper	2 Rectangle	N	Y	Y	N	N	'04 - Newer	N
<b>05X8NL<sup>2</sup></b>	Chrome	10Ga	14" Taper	N	N	Y	Y	N	N	'04 - Newer	N

1. Recessed Hitch

2. Surface Mount Hitch

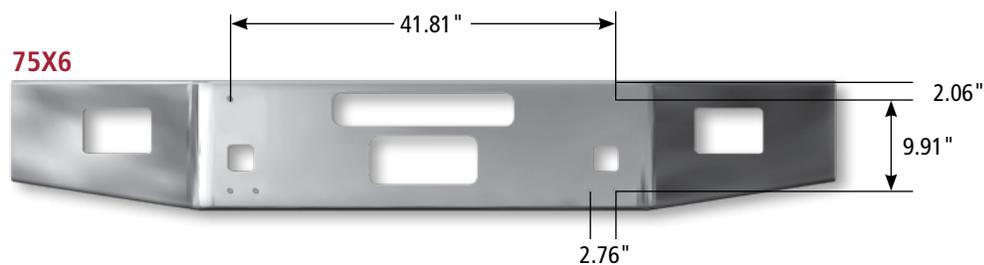

## W900B / W900L

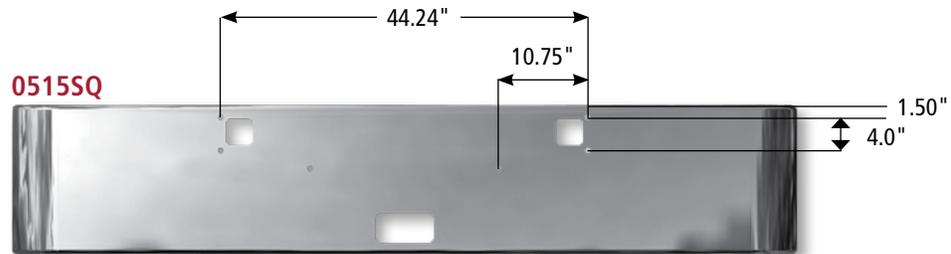

PART NO.	MATERIAL / FINISH	GAUGE / THICKNESS	STYLE	LIGHT	CENTER STEP	VENT	TOW	RADAR	EXCLUSIVE THROUGH OEM	YEAR	MOUNT / BRACKET	TIRE SHIELDS
<b>7512SQ</b>	Chrome	7Ga	18" Texas Square	N	N	N	Y	N	N	'82 - Newer	N	Y
<b>0574SQ</b>	Chrome	10Ga	18" Texas Square	9 Oval	N	N	Y	N	N	'82 - Newer	N	Y
<b>0514SQ</b>	Chrome	10Ga	18" Texas Square	2 Rectangle	Y	N	Y	N	N	'82 - Newer	N	Y
<b>7514</b>	Chrome	7Ga	16" Taper	2 Rectangle	Y	N	Y	N	N	'82 - Newer	N	Y
<b>7514SQ</b>	Chrome	7Ga	18" Texas Square	2 Rectangle	Y	N	Y	N	N	'82 - Newer	N	Y
<b>0515IN18</b>	Chrome	10Ga	18" Taper	N	Y	N	Y	N	N	'82 - Newer	N	N
<b>0515SSCSQ</b>	AERO CLAD®	0.125"	18" Texas Square	N	Y	N	Y	N	Y	'82 - Newer	Y	Y
<b>0515NSSQ</b>	Chrome	10Ga	18" Texas Square	N	Y	N	Y	N	N	'82 - Newer	N	N
<b>0515SQ</b>	Chrome	10Ga	18" Texas Square	N	Y	N	Y	N	N	'82 - Newer	N	Y
<b>0515STQ</b>	Polished Stainless	11Ga	18" Texas Square	N	Y	N	Y	N	N	'82 - Newer	N	Y
<b>7514NS</b>	Chrome	7Ga	16" Taper	2 Rectangle	Y	N	Y	N	N	'82 - Newer	N	N
<b>7515NS</b>	Chrome	7Ga	16" Taper	N	Y	N	Y	N	N	'82 - Newer	N	N
<b>7515</b>	Chrome	7Ga	16" Taper	N	Y	N	Y	N	N	'82 - Newer	N	Y
<b>7515SQ</b>	Chrome	7Ga	18" Texas Square	N	Y	N	Y	N	N	'82 - Newer	N	Y
<b>0521SQ</b>	Chrome	10Ga	20" Box	N	N	N	Y	N	N	'82 - Newer	N	Y
<b>0522SQ</b>	Chrome	10Ga	18" Texas Square	N	N	N	Y	N	N	'82 - Newer	N	Y

## T660

### **H AERO CLAD®** Stainless Steel Clad Aluminum Bumper

#### AERO CLAD® Features and Benefits

- Durable, bright mirrored finish
- 10 times thicker finish than chrome
- Resists corrosion, cracking, pitting, peeling and fading
- Lightweight design
- High ground clearance
- Minor abrasions can be buffed
- Full 5-year limited warranty\*

\* Contact your local Hendrickson representative for complete warranty terms, conditions and limitations.



PART NO.	MATERIAL / FINISH	GAUGE / THICKNESS	STYLE	LIGHT	CENTER STEP	VENT	TOW	RADAR	EXCLUSIVE THROUGH OEM	YEAR	MOUNT / BRACKET
<b>05R1NLSSC</b>	AERO CLAD®	0.125"	14" Set Back	N	N	Y	Y	N	N	'08 - '17	Y
<b>05R1NLVSSC</b>	AERO CLAD	0.125"	14" Set Back	N	N	Y	Y	Y	N	'08 - '17	Y
<b>05R1SSC¹</b>	AERO CLAD	0.125"	14" Set Back	Y	N	Y	Y	N	N	'08 - '17	Y
<b>05R1VSSC¹</b>	AERO CLAD	0.125"	14" Set Back	Y	N	Y	Y	Y	N	'08 - '17	Y
<b>05R1NLBAX</b>	Steel Primed	10Ga	14" Set Back	N	N	Y	Y	N	N	'08 - '17	Y
<b>05R1NLVBAX</b>	Steel Primed	10Ga	14" Set Back	N	N	Y	Y	Y	N	'08 - '17	Y
<b>05R1VBAX¹</b>	Steel Primed	10Ga	14" Set Back	Y	N	Y	Y	Y	N	'08 - '17	Y

1. Includes light bezel trim

## CH600 / CH

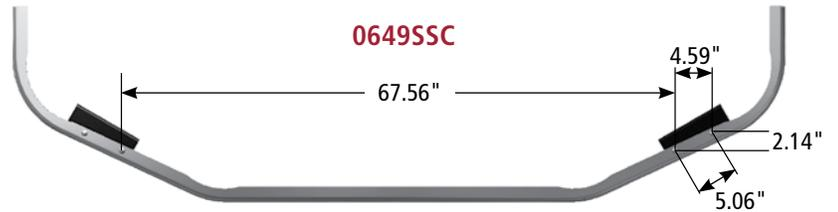

PART NO.	MATERIAL / FINISH	GAUGE / THICKNESS	STYLE	LIGHT	CENTER STEP	VENT	TOW	RADAR	EXCLUSIVE THROUGH OEM	YEAR	MOUNT / BRACKET
<b>0636BSX</b>	Steel Primed	10Ga	13.5" Set Forward	N	Y	N	Y	N	N	'96 - Newer	Y
<b>0636SSC</b>	AERO CLAD®	0.125"	13.5" Set Forward	N	Y	N	Y	N	N	'96 - Newer	Y
<b>0637SSC</b>	AERO CLAD	0.125"	13.5" Set Forward	Y	Y	N	Y	N	N	'96 - Newer	Y
<b>0648BSX</b>	Steel Primed	10Ga	13.5" Set Back	N	Y	N	Y	N	N	'96 - Newer	Y
<b>0648SSC</b>	AERO CLAD	0.125"	13.5" Set Back	N	Y	N	Y	N	N	'96 - Newer	Y
<b>0649BSX</b>	Steel Primed	10Ga	17.65" Set Back	Y	Y	N	Y	N	N	'96 - Newer	Y
<b>0649SSC</b>	AERO CLAD	0.125"	13.5" Set Back	Y	Y	N	Y	N	N	'96 - Newer	Y
<b>0653SSC</b>	AERO CLAD	0.125"	13.5" Set Back	N	Y	N	Y	N	N	'96 - Newer	Y





## CL

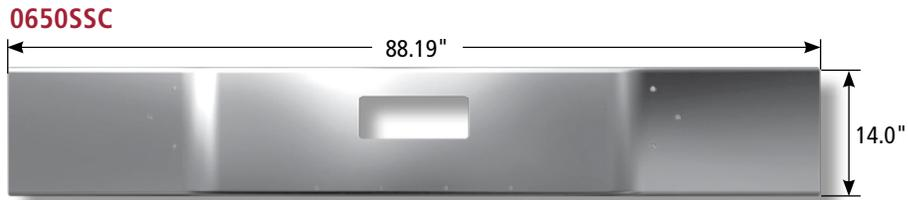

PART NO.	MATERIAL / FINISH	GAUGE / THICKNESS	STYLE	LIGHT	CENTER STEP	VENT	TOW	RADAR	EXCLUSIVE THROUGH OEM	YEAR	MOUNT / BRACKET
<b>0650SSC</b>	AERO CLAD®	0.125"	14" Set Back	N	Y	N	N	N	N	—	N
<b>0651SSC</b>	AERO CLAD	0.125"	14" Set Back	N	N	N	Y	N	N	—	N

## DM

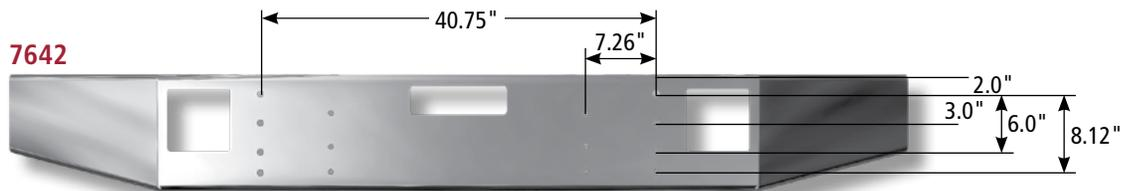

PART NO.	MATERIAL / FINISH	GAUGE / THICKNESS	STYLE	LIGHT	CENTER STEP	VENT	TOW	RADAR	EXCLUSIVE THROUGH OEM	YEAR	MOUNT / BRACKET
<b>7642</b>	Chrome	8Ga	12" Taper	N	N	Y	Y	N	N	'86 - '97	N

## GRANITE



PART NO.	MATERIAL / FINISH	GAUGE / THICKNESS	STYLE	LIGHT	CENTER STEP	VENT	TOW	RADAR	EXCLUSIVE THROUGH OEM	YEAR	MOUNT / BRACKET
<b>7645SSC</b>	AERO CLAD	0.160"	Set Forward 16" Taper	N	Y	N	Y	N	N	'03 - '04	N





## R

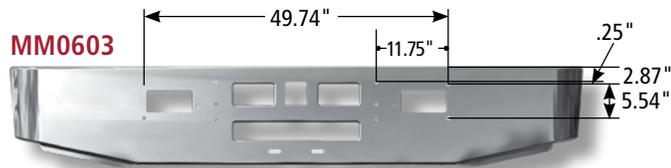

PART NO.	MATERIAL / FINISH	GAUGE / THICKNESS	STYLE	LIGHT	CENTER STEP	VENT	TOW	RADAR	EXCLUSIVE THROUGH OEM	YEAR	MOUNT / BRACKET
<b>MM0603</b>	Chrome	10Ga	16" Taper	N	N	Y	Y	N	Y	'97 - Newer	N

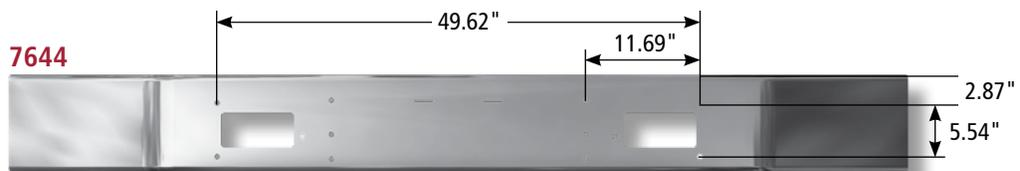

## RD

Set back axle with tow holes and cow catcher holes

PART NO.	MATERIAL / FINISH	GAUGE / THICKNESS	STYLE	LIGHT	CENTER STEP	VENT	TOW	RADAR	EXCLUSIVE THROUGH OEM	YEAR	MOUNT / BRACKET
<b>7643*</b>	Chrome	8Ga	10" Set Back	N	N	N	N	N	Y	'89 - '98	N
<b>7644*</b>	Chrome	8Ga	10" Set Back	N	N	N	Y	N	Y	—	N

\*Includes cow catcher holes

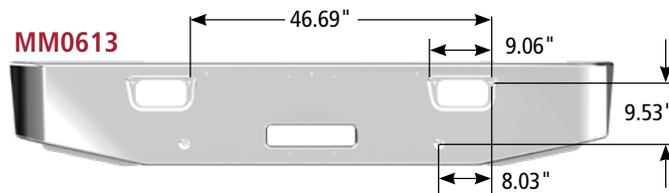

## SUPERLINER II

PART NO.	MATERIAL / FINISH	GAUGE / THICKNESS	STYLE	LIGHT	CENTER STEP	VENT	TOW	RADAR	EXCLUSIVE THROUGH OEM	YEAR	MOUNT / BRACKET
<b>MM0613</b>	Chrome	10Ga	15" Taper	N	Y	N	Y	N	Y	—	N

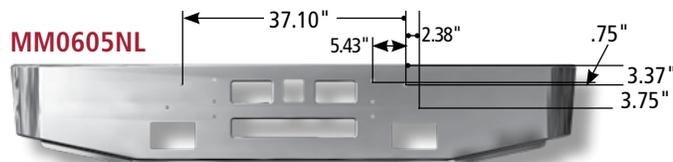

## U

PART NO.	MATERIAL / FINISH	GAUGE / THICKNESS	STYLE	LIGHT	CENTER STEP	VENT	TOW	RADAR	EXCLUSIVE THROUGH OEM	YEAR	MOUNT / BRACKET
<b>MM0605NL</b>	Chrome	10Ga	16" Taper	N	N	Y	Y	N	Y	—	N



## MACK ANTHEM® / PINNACLE CXU / VISION CX

### **H** AERO CLAD®

Stainless Steel Clad  
Aluminum Bumper

#### AERO CLAD® Features and Benefits

- Durable, bright mirrored finish
- 10 times thicker finish than chrome
- Resists corrosion, cracking, pitting, peeling and fading
- Lightweight design
- Minor abrasions can be buffed
- Full 5-year limited warranty\*

\* Contact your local Hendrickson representative for complete warranty terms, conditions and limitations.



PART NO.	MATERIAL / FINISH	GAUGE / THICKNESS	STYLE	LIGHT	CENTER STEP	VENT	TOW	RADAR COMPATIBLE	EXCLUSIVE THROUGH OEM	YEAR	MOUNT / BRACKET*
<b>7665SSC</b>	AERO CLAD®	0.160"	16.5" Set Back	N	Y	N	Y	N	Y	'02 - '05 Vision CX	N
<b>7664SSC</b>	AERO CLAD	0.160"	16.5" Set Back	2 Square	Y	N	Y	N	Y	'02 - '05 Vision CX	N
<b>MM5620NLSSC</b>	AERO CLAD	0.160"	16.5" Set Back	N	Y	Y	Y	Y	Y	'06 - '17 Pinnacle CXU '18 - Newer Anthem®	N
<b>MM5620SSC</b>	AERO CLAD	0.160"	16.5" Set Back	2 Round	Y	Y	Y	Y	Y	'06 - '17 Pinnacle CXU '18 - Newer Anthem	N

\*NOTE: Converting an OEM Vision CX or Pinnacle CXU flush mount bumper to AERO CLAD requires mounting brackets 84741418 and 84741419. Extended mount bumpers require brackets 84741412 and 84741413.

Converting an OEM Anthem composite bumper to AERO CLAD requires one 84750643 LH bracket, one 84750644 RH bracket and two 84753681 brackets.

Mounting brackets and associated hardware are available through your Mack dealer.



## 330

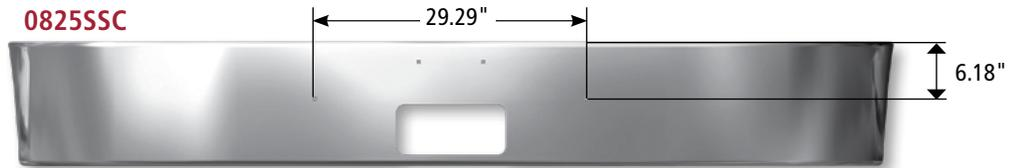

PART NO.	MATERIAL / FINISH	GAUGE / THICKNESS	STYLE	LIGHT	CENTER STEP	VENT	TOW	RADAR	EXCLUSIVE THROUGH OEM	YEAR	MOUNT / BRACKET
<b>0825SSC</b>	AERO CLAD®	0.125"	13.5" Set Back, 12K	N	N	N	Y	N	Y	'02 - '08	N
<b>0826SSC</b>	AERO CLAD	0.125"	16" Set Back, 16K	N	N	N	Y	N	Y	'97 - Newer	N

## 359 CONVENTIONAL '67-'86 / 352 COE '67-'80

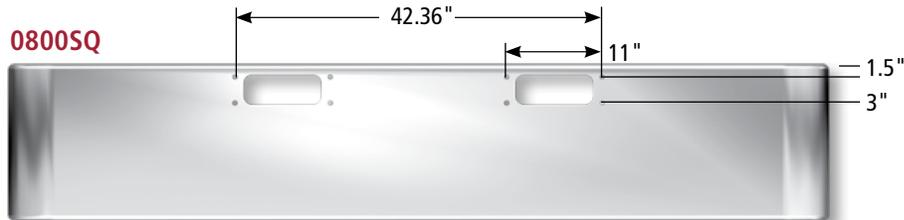

PART NO.	MATERIAL / FINISH	GAUGE / THICKNESS	STYLE	LIGHT	CENTER STEP	VENT	TOW	RADAR	EXCLUSIVE THROUGH OEM	YEAR	MOUNT / BRACKET
<b>0800SQ</b>	Chrome	10Ga	18" TSQ	N	N	N	Y	N	N	'67 - '86	N

## 367 / 567

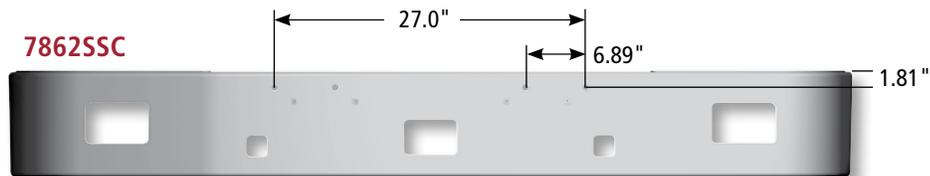

PART NO.	MATERIAL / FINISH	GAUGE / THICKNESS	STYLE	LIGHT	CENTER STEP	VENT	TOW	RADAR	EXCLUSIVE THROUGH OEM	YEAR	MOUNT / BRACKET
<b>7862SSC*</b>	AERO CLAD	0.160"	12" Set Back	2 Rectangle	Y	N	Y	N	Y	'07 - Newer	Y
<b>7862NLSSC*</b>	AERO CLAD	0.160"	12" Set Back	N	Y	N	Y	N	Y	'07 - Newer	Y

\*Includes treadplates

## 365 SFFA, 367 SFFA, 388, 389

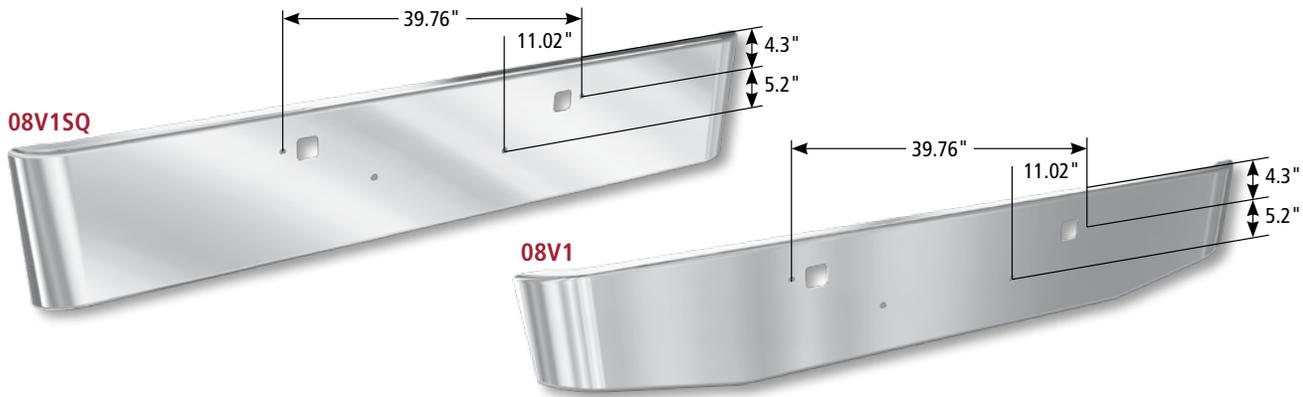

PART NO.	MATERIAL / FINISH	GAUGE / THICKNESS	STYLE	LIGHT	CENTER STEP	VENT	TOW	RADAR	EXCLUSIVE THROUGH OEM	YEAR	LICENSE PLATE HOLES	TIRE SHIELDS
<b>08V1</b>	Chrome	10Ga	16" Taper	N	N	N	Y	N	N	'06 - Newer	N	N
<b>08V11NSSQ</b>	Chrome	10Ga	18" Texas Square	N	N	N	Y	N	N	'06 - Newer	N	N
<b>08V1SQ</b>	Chrome	10Ga	18" Texas Square	N	N	N	Y	N	N	'06 - Newer	N	Y
<b>08V2SQ</b>	Chrome	10Ga	18" Texas Square	N	Y	N	Y	N	N	'06 - Newer	N	Y
<b>08V3*</b>	Chrome	10Ga	16" Taper	N	N	N	Y	N	N	'06 - Newer	N	N
<b>08V4</b>	Chrome	10Ga	16" Taper	N	N	N	Y	N	N	'06 - Newer	Single	N
<b>08V5</b>	Chrome	10Ga	16" Taper	N	N	N	Y	N	N	'06 - Newer	Dual	N
<b>78V1SQ</b>	Chrome	7Ga	18" Texas Square	N	N	N	Y	N	N	'06 - Newer	N	Y
<b>08V1IN12</b>	Chrome	10Ga	12" Taper	N	N	N	Y	N	N	'06 - Newer	N	N
<b>78V1SQ18</b>	Chrome	7Ga	18" Boxed End	N	N	N	Y	N	N	'06 - Newer	N	Y
<b>78V1SQ20</b>	Chrome	7Ga	20" Boxed End	N	N	N	Y	N	N	'06 - Newer	N	Y
<b>08V11NS</b>	Chrome	10Ga	16" Taper	2 Rectangle	N	N	Y	N	N	'06 - Newer	N	N
<b>08V11NSSQ</b>	Chrome	10Ga	18" Texas Square	N	N	N	Y	N	N	'06 - Newer	N	N
<b>08V12SQ</b>	Chrome	10Ga	18" Texas Square	2 Rectangle	N	N	Y	N	N	'06 - Newer	N	Y
<b>08V13SQ</b>	Chrome	10Ga	18" Boxed End	N	N	N	Y	N	N	'06 - Newer	Single	Y
<b>08V8NLSQ</b>	Chrome	10Ga	18" Texas Square	N	N	N	Y	N	N	'06 - Newer	Dual	Y
<b>08V8SQ</b>	Chrome	10Ga	18" Texas Square	2 Rectangle	N	N	Y	N	N	'06 - Newer	Dual	Y
<b>08V1NTSQ</b>	Chrome	10Ga	18" Texas Square	N	N	N	N	N	N	'06 - Newer	N	Y

\*Surface mount hitch

## 357 / 378 / 379

PART NO.	MATERIAL / FINISH	GAUGE / THICKNESS	STYLE	LIGHT	CENTER STEP	VENT	TOW	RADAR	EXCLUSIVE THROUGH OEM	YEAR	MOUNT / BRACKET	TIRE SHIELDS
<b>0804</b>	Chrome	10Ga	16" Taper	N	N	N	Y	N	N	'87 - '06	N	Y
<b>0804NS</b>	Chrome	10Ga	16" Taper	N	N	N	Y	N	N	'87 - '06	N	N
<b>0805</b>	Chrome	10Ga	16" Taper	2 Rectangle	N	N	Y	N	N	'87 - '06	N	Y
<b>0813</b>	Chrome	10Ga	16" Taper	N	N	N	Y	N	N	'87 - '06	N	Y
<b>0894</b>	Chrome	10Ga	16" Taper	N	N	N	Y	N	N	'87 - '06	N	Y
<b>7804</b>	Chrome	7Ga	16" Taper	N	N	N	Y	N	N	'87 - '06	N	Y
<b>0804IN12</b>	Chrome	10Ga	12" Taper	N	N	N	Y	N	N	'87 - '06	N	N
<b>0804NSSQ</b>	Chrome	10Ga	18" Texas Square	N	N	N	Y	N	N	'87 - '06	N	N
<b>0804NTSQ</b>	Chrome	10Ga	18" Texas Square	N	N	N	N	N	N	'87 - '06	N	Y
<b>0804SQ</b>	Chrome	10Ga	18" Texas Square	N	N	N	Y	N	N	'87 - '06	N	Y
<b>0804SSC</b>	AERO CLAD®	0.160"	16" Taper	N	N	N	Y	N	N	'87 - '06	N	N
<b>0804STQ</b>	Polished Stainless	11Ga	18" Texas Square	N	N	N	Y	N	N	'87 - '06	N	Y
<b>0805NSSQ</b>	Chrome	10Ga	18" Texas Square	2 Rectangle	N	N	Y	N	N	'87 - '06	N	N
<b>0805SQ</b>	Chrome	10Ga	18" Texas Square	2 Rectangle	N	N	Y	N	N	'87 - '06	N	Y
<b>0805NS</b>	Chrome	10Ga	16" Taper	2 Rectangle	N	N	Y	N	N	'87 - '06	N	N
<b>0807NSSQ</b>	Chrome	10Ga	18" Boxed End	N	N	N	Y	N	N	'87 - '06	N	N
<b>0807SQ</b>	Chrome	10Ga	18" Boxed End	N	N	N	Y	N	N	'87 - '06	N	Y
<b>0809NSSQ20</b>	Chrome	10Ga	20" Boxed End	N	N	N	Y	N	N	'87 - '06	N	N
<b>0809SQ20</b>	Chrome	10Ga	20" Boxed End	N	N	N	Y	N	N	'87 - '06	N	Y
<b>0844SQ</b>	Chrome	10Ga	18" Texas Square	4 Oval	N	N	Y	N	N	'87 - '06	N	Y
<b>0864SQ</b>	Chrome	10Ga	18" Texas Square	6 Oval	N	N	Y	N	N	'87 - '06	N	Y
<b>0874SQ</b>	Chrome	10Ga	18" Texas Square	9 Oval	N	N	Y	N	N	'87 - '06	N	Y
<b>0884SQ</b>	Chrome	10Ga	18" Texas Square	15 Round	N	N	Y	N	N	'87 - '06	N	Y
<b>7804NS</b>	Chrome	7Ga	16" Taper	N	N	N	Y	N	N	'87 - '06	N	N
<b>7804SQ</b>	Chrome	7Ga	18" Texas Square	N	N	N	Y	N	N	'87 - '06	N	Y
<b>7807NSSQ</b>	Chrome	7Ga	18" Boxed End	N	N	N	Y	N	N	'87 - '06	N	N
<b>7807SQ</b>	Chrome	7Ga	18" Boxed End	N	N	N	Y	N	N	'87 - '06	N	Y
<b>7809NSSQ20</b>	Chrome	7Ga	20" Boxed End	N	N	N	Y	N	N	'87 - '06	N	N
<b>7809SQ20</b>	Chrome	7Ga	20" Boxed End	N	N	N	Y	N	N	'87 - '06	N	Y
<b>0894IN12</b>	Chrome	10Ga	12" Taper	N	N	N	Y	N	N	'87 - '06	N	N

## 385

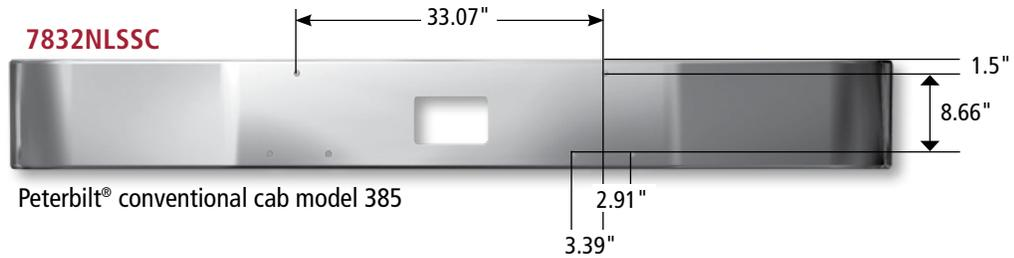

Peterbilt® conventional cab model 385

PART NO.	MATERIAL / FINISH	GAUGE / THICKNESS	STYLE	LIGHT	CENTER STEP	VENT	TOW	RADAR	EXCLUSIVE THROUGH OEM	YEAR	MOUNT / BRACKET
<b>7832NLSSC</b>	AERO CLAD®	0.160"	12" Set Back	N	N	N	Y	N	N	'96 - '07	Y
<b>7832SSC</b>	AERO CLAD	0.160"	12" Set Back	2 Rectangle	N	N	Y	N	N	'96 - '07	Y

## 387

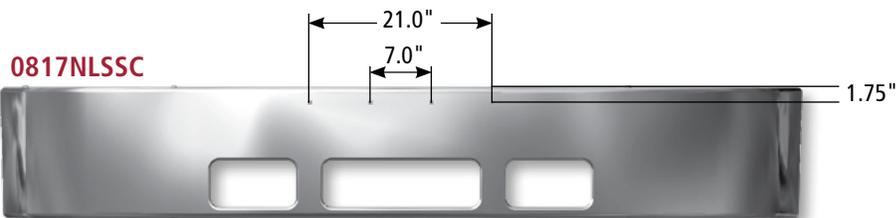

PART NO.	MATERIAL / FINISH	GAUGE / THICKNESS	STYLE	LIGHT	CENTER STEP	VENT	TOW	RADAR	EXCLUSIVE THROUGH OEM	YEAR	MOUNT / BRACKET
<b>0817NLSSC</b>	AERO CLAD	0.125"	15" Set Back	N	Y	N	Y	N	Y	'02 - '10	Y
<b>0817SSC</b>	AERO CLAD	0.125"	15" Set Back	2 Rectangle	Y	N	Y	N	Y	'02 - '10	Y
<b>0818NLSSC</b>	AERO CLAD	0.125"	15" Set Back	N	Y	N	Y	Y	Y	'02 - '10	Y
<b>0818SSC</b>	AERO CLAD	0.125"	15" Set Back	2 Rectangle	Y	N	Y	Y	Y	'02 - '10	Y



## 384 / 386

### **H** AERO CLAD®

Stainless Steel Clad  
Aluminum Bumper

#### Features and Benefits

- Durable, bright mirrored finish
- 10 times thicker finish than chrome
- Resists corrosion, cracking, pitting, peeling and fading
- Minor abrasions can be buffed
- Full 5-year limited warranty\*

\* Contact your local Hendrickson representative for complete warranty terms, conditions and limitations.



PART NO.	MATERIAL / FINISH	GAUGE / THICKNESS	STYLE	LIGHT	CENTER STEP	VENT	TOW	RADAR	EXCLUSIVE THROUGH OEM	YEAR	MOUNT / BRACKET
<b>0889NLSSC</b>	AERO CLAD®	0.125"	13.5" Set Back	N	Y	N	Y	N	Y	'06 - Newer	Y
<b>0889SSC</b>	AERO CLAD	0.125"	13.5" Set Back	2 Rectangle	Y	N	Y	N	Y	'06 - Newer	Y

When replacing an OE composite molded bumper, spacers N80 - 6006 & N80 - 6006R are required.  
No spacers required when replacing OE metal bumper.

## 587

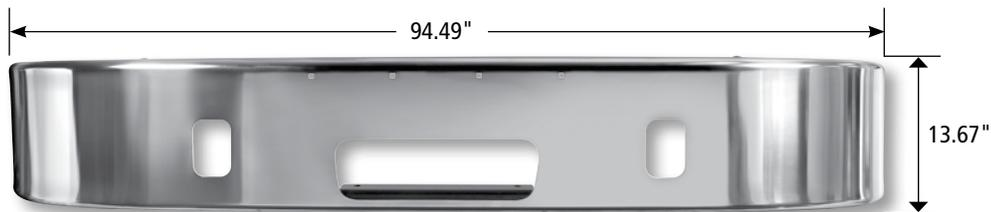

PART NO.	MATERIAL / FINISH	GAUGE / THICKNESS	STYLE	LIGHT	CENTER STEP	VENT	TOW	RADAR	EXCLUSIVE THROUGH OEM	YEAR	MOUNT / BRACKET
<b>08E0NLSSC</b>	AERO CLAD	0.125"	13.5" Set Back	N	Y	N	Y	N	Y	ALL	Y



## VNM



PART NO.	MATERIAL / FINISH	GAUGE / THICKNESS	STYLE	LIGHT	CENTER STEP	VENT	TOW	RADAR	EXCLUSIVE THROUGH OEM	YEAR	MOUNT / BRACKET
<b>0944SSC</b>	AERO CLAD®	0.125"	12" Set Back	2 Oval	N	Y	Y	N	N	'04 - '17	Y

## WG

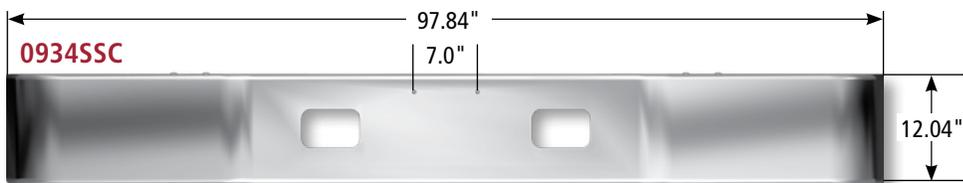

PART NO.	MATERIAL / FINISH	GAUGE / THICKNESS	STYLE	LIGHT	CENTER STEP	VENT	TOW	RADAR	EXCLUSIVE THROUGH OEM	YEAR	MOUNT / BRACKET
<b>0934SSC</b>	AERO CLAD	0.125"	12" Set Back	N	N	N	Y	N	N	—	Y





## New VNL

### **H** AERO CLAD®

Stainless Steel Clad Aluminum Bumper

#### Features and Benefits

- Lightweight design
- Easy installation to factory mounts
- Durable, bright mirrored finish
- 10 times thicker finish than chrome
- Resists corrosion, cracking, pitting, peeling and fading
- Quality, American made product
- Minor abrasions can be buffed
- Full 5-year limited warranty\*



MM29644LSSC shown with optional air dam, MM602243K

\* Contact your local Hendrickson representative for complete warranty terms, conditions and limitations.

PART NO.	MATERIAL / FINISH	GAUGE / THICKNESS	STYLE <sup>1</sup>	LIGHT	CENTER STEP	VENT	TOW	RADAR COMPATIBLE <sup>2</sup>	EXCLUSIVE THROUGH OEM	YEAR	MOUNT / BRACKET <sup>3</sup>	LICENSE PLATE HOLES
<b>MM2964SSC</b>	AERO CLAD®	0.125"	LWO Closed End	2 lights	N	Y	Y	Y	Y	2018 - Newer	Y	Y
<b>MM29644LSSC</b>	AERO CLAD	0.125"	LWO Closed End	4 lights	N	Y	Y	Y	Y	2018 - Newer	Y	Y
<b>MM2964NLSSC</b>	AERO CLAD	0.125"	LWO Closed End	N	N	Y	Y	Y	Y	2018 - Newer	Y	Y
<b>MM2965SSC</b>	AERO CLAD	0.125"	SWO Closed End	2 lights	N	Y	Y	Y	Y	2018 - Newer	Y	Y
<b>MM29654LSSC</b>	AERO CLAD	0.125"	SWO Closed End	4 lights	N	Y	Y	Y	Y	2018 - Newer	Y	Y
<b>MM2965NLSSC</b>	AERO CLAD	0.125"	SWO Closed End	N	N	Y	Y	Y	Y	2018 - Newer	Y	Y
<b>MM602243K<sup>4</sup></b>	TPO	–	Air Dam Kit	–	–	–	–	–	–	–	–	–

1. Standard Wheel Opening (SWO) for use with 22.5" diameter tire / Large Wheel Opening (LWO) for use with 24.5" diameter tire

2. Radar compatible unit is mounted off the cross member behind the bumper

3. Supplied with mounting brackets installed on bumper

4. Air dam sold separately



## VNL

### **AERO CLAD®**

Stainless Steel Clad  
Aluminum Bumper

#### AERO CLAD® Features and Benefits

- Lightweight design – no adverse effect on fuel consumption
- Easy installation to factory mounts
- Mounting brackets included
- Durable, bright mirrored finish
- 10 times thicker finish than chrome
- Resists corrosion, cracking, pitting, peeling and fading
- Minor abrasions can be buffed
- Full 5-year limited warranty\*



**MM0960SSC**  
**(0961ADA-Optional)**



### **STEEL 10-GAUGE BUMPER**

#### Features and Benefits

- Easy installation to factory mounts
- Mounting brackets included
- Corrosion resistant e-coat finish, ready for top coat
- Manufactured with high-impact corrosion resistant steel
- Optional air dam that bolts up to factory installed belly pan can be attached to this bumper
- 1-year limited warranty\*



\* Contact your local Hendrickson representative for complete warranty terms, conditions and limitations.



**MM0961BAX**



## VNL cont.

PART NO.	MATERIAL / FINISH	GAUGE / THICKNESS	STYLE	LIGHT	CENTER STEP	VENT	TOW	RADAR	EXCLUSIVE THROUGH OEM	YEAR	MOUNT / BRACKET
<b>0940SSC</b>	AERO CLAD®	0.125"	—	N	N	Y	Y	N	Y	'98 - '03	Y
<b>MM0960NLSSC<sup>1</sup></b>	AERO CLAD	0.125"	—	N	N	Y	Y	N	N	'03 - '17	Y
<b>MM0960SSC<sup>1</sup></b>	AERO CLAD	0.125"	—	2 Rectangle	N	Y	Y	N	N	'03 - '17	Y
<b>MM0961BAX<sup>2</sup></b>	Steel Prime	10Ga	—	2 Rectangle	N	Y	Y	N	N	'03 - '17	Y
<b>MM0961NLBAX<sup>2</sup></b>	Steel Prime	10Ga	—	N	N	Y	Y	N	N	'03 - '17	Y
<b>MM0961NLSSC<sup>2</sup></b>	AERO CLAD	0.125"	—	N	N	Y	Y	N	N	'03 - '17	Y
<b>MM0961SSC<sup>2</sup></b>	AERO CLAD	0.125"	—	2 Rectangle	N	Y	Y	N	N	'03 - '17	Y
<b>MM0963BAX<sup>2</sup></b>	Steel Prime	10Ga	—	2 Rectangle	N	Y	Y	Y	N	'03 - '17	Y
<b>0961ADA</b>	ABS	0.187"	VNL AIR DAM KIT	—	—	—	—	—	—	—	—

1. Basic - to be used with small wheel trim 22.5" diameter tire.
2. Extended - to be used with large wheel trim 24.5" diameter tire.





## CONVENTIONAL / 4964 CONSTELLATION & HERITAGE

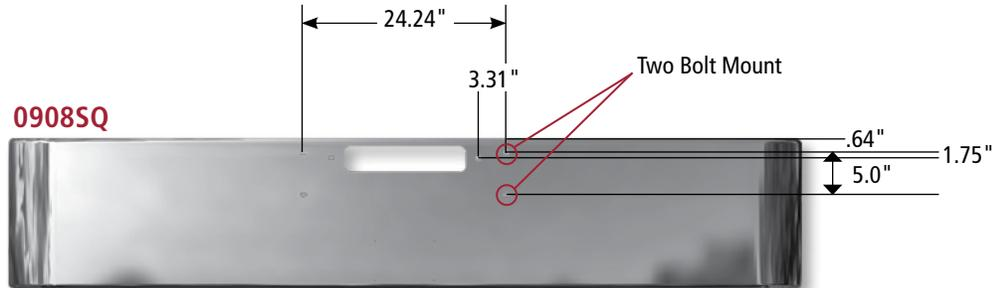

PART NO.	MATERIAL / FINISH	GAUGE / THICKNESS	STYLE	LIGHT	CENTER STEP	VENT	TOW	RADAR	EXCLUSIVE THROUGH OEM	YEAR	MOUNT / BRACKET	TIRE SHIELDS
<b>0907<sup>1</sup></b>	Chrome	10Ga	16" Taper	2 Rectangle	N	N	Y	N	N	'89 - '07	N/A	Y
<b>0907SQ<sup>1</sup></b>	Chrome	10Ga	18" Texas Square	2 Rectangle	N	N	Y	N	N	'89 - '07	N/A	Y
<b>0908<sup>1</sup></b>	Chrome	10Ga	16" Taper	N	N	N	Y	N	N	'89 - '07	N/A	Y
<b>0908SQ<sup>1</sup></b>	Chrome	0.125"	18" Texas Square	N	N	N	Y	N	N	'89 - '07	N/A	Y
<b>0909SQ<sup>1</sup></b>	Chrome	0.125"	18" Texas Square	N	N	N	N	N	N	'89 - '07	N/A	Y
<b>0910<sup>2</sup></b>	Chrome	10Ga	16" Taper	N	N	N	N	N	N	'89 - '07	N/A	Y
<b>0911SQ<sup>2</sup></b>	Chrome	10Ga	18" Texas Square	2 Rectangle	N	N	N	N	N	'89 - '07	N/A	Y
<b>0913SQ<sup>1</sup></b>	Chrome	0.125"	18" Texas Square	8 Oval	N	N	Y	N	N	'89 - '07	N/A	Y
<b>7907<sup>1</sup></b>	Chrome	8Ga	16" Taper	2 Rectangle	N	N	Y	N	N	'89 - '07	N/A	Y
<b>7908<sup>1</sup></b>	Chrome	8Ga	16" Taper	N	N	N	Y	N	N	'89 - '07	N/A	Y

- 1. Three bolt mount
- 2. Two bolt mount

**NOTE:** Brackets are not included



# AERO CLAD® ROCK SCREENS

## Features and Benefits

- Lightweight
- Easy installation
- Durable, bright mirrored finish
- Resists corrosion, cracking, pitting, peeling and fading
- Quality, American made product
- Protects radiator from gravel / rocks and other road debris
- Airflow into the cooling module
- Integrated appearance

## Part Numbers

PART NO.	MATERIAL	CUT OUT STYLE	MODEL	RADAR	NUMBER OF PIECES	EXCLUSIVE
402631KS	.125 AERO CLAD®	Freightliner® Logo Silhouette	New Cascadia®	Y	2	Y
402632KS	.125 AERO CLAD	Freightliner Logo Silhouette	New Cascadia	N	1	Y
402627KS	.125 AERO CLAD	Hexagon Shaped	New Cascadia	Y	2	N
402626KS	.125 AERO CLAD	Hexagon Shaped	New Cascadia	N	1	N

Freightliner® Logo Silhouette Cutouts



Hexagon Cutouts

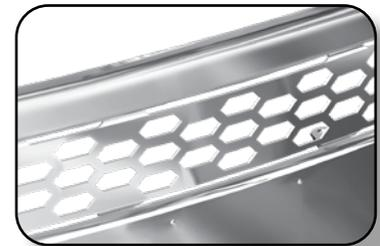

# Finding the right bumper is as easy as 1-2-3.

## Step 1.

Visit [www.hendrickson-intl.com/bumper](http://www.hendrickson-intl.com/bumper) to utilize the bumper selector tool.

## Step 2.

Configure your bumper using easy to navigate menu of options to obtain the Hendrickson ALL Makes part number.

## Step 3.

Email, print or send your bumper configuration with a simple click.

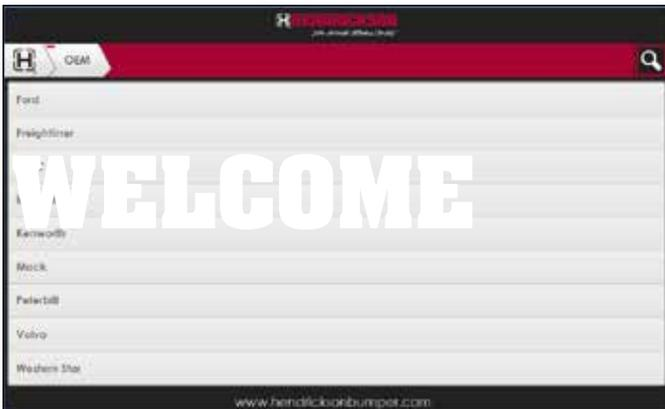

# Additional product listings and useful information are only a click away!

Check out our selection and browse our current literature.

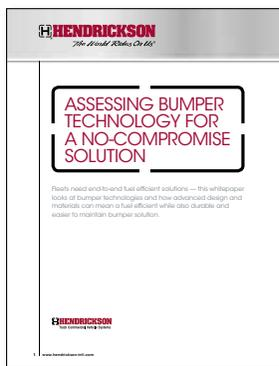

## Aerodynamics Study

Fuel consumption testing compares AERO CLAD® bumper technology with alternative plastic bumpers.



## Bumper Mobile APP

The Innovative "Truck Bumper Selector Tool" mobile app is available for Apple and Android mobile phone and tablet devices.



## Bumper Selector Tool

Use our new interactive tool to configure your bumper and cross reference OEM and all makes numbers.

**Visit us at [www.hendricksonbumper.com](http://www.hendricksonbumper.com)**

If you can't find what you need, please call Customer Service at 815.727.4031.



# GENUINE HENDRICKSON

## ALL MAKES PROGRAM

Hendrickson's All Makes Bumper Program offers aftermarket replacement bumpers designed to be a less expensive alternative to the original equipment. The All Makes Program provides parts personnel a wider variety of bumpers than those available through an OEM.

- Comprehensive line of materials and finishes
- New catalog with photos and features / benefits
- Build a bumper configurator available on Hendrickson web site
- Premium grade materials for high quality and finishing
- Free mobile app for more popular bumper selections
- Hundreds of bumper options
- Metal and non-metal bumpers



*for*  
**ENGINEERED  
EFFICIENCY™**

# **AERO CLAD®**

**Stainless steel clad aluminum bumpers**



**HENDRICKSON**

[www.hendrickson-intl.com/BUMPER](http://www.hendrickson-intl.com/BUMPER)

## **LESS MAINTENANCE**

Weight savings, less maintenance and improved fit and finish compared to chrome bumpers. In addition, AERO CLAD features greater ground clearance while maintaining fuel efficiency and backed by a 5-year warranty\*.

\*Contact your local Hendrickson representative for complete warranty terms, conditions and limitations.

---

*Hendrickson has a comprehensive product offering of heavy-duty truck bumpers for OEM and aftermarket needs. Hendrickson products feature advanced materials specifically designed for bumpers and flexible manufacturing technology to help provide customers value through durability, weight reduction and fuel economy.*

---

*Actual product performance may vary depending upon vehicle configuration, operation, service and other factors. All applications must comply with applicable Hendrickson specifications and must be approved by the respective vehicle manufacturer with the vehicle in its original, as-built configuration. Contact Hendrickson for additional details regarding specifications, applications, capacities, and operation, service and maintenance instructions.*

**Call Hendrickson at 815.727.4031 for additional information.**



[www.hendrickson-intl.com](http://www.hendrickson-intl.com)

**SPECIALTY PRODUCTS - BUMPER AND TRIM**

501 Caton Farm Road  
Lockport, IL 60441 USA  
815.727.4031 | fax 815.727.9697  
[hbatcustservice@hendrickson-intl.com](mailto:hbatcustservice@hendrickson-intl.com)

C154 Rev P 03-21

© 2011 - 2021 Hendrickson USA, L.L.C. All Rights Reserved. All trademarks shown are owned by Hendrickson USA, L.L.C., or one of its affiliates, in one or more countries, except for those trademarks owned by the respective vehicle manufacturer. Information contained in this literature was accurate at the time of publication. Product changes may have been made after the copyright date that are not reflected.

Printed in United States of America